

# Alma Bridge Road Newt Passage Project Technical Review (Phase I)



## **Alma Bridge Road Newt Passage Project**

WILDLIFE CONNECTIVITY IMPROVEMENTS

Prepared by:

AECOM

300 Lakeside Drive, Suite 400

Oakland, CA 94612

T: 510.893.3600

F: 510.874.3268

[www.aecom.com](http://www.aecom.com)

# Table of Contents

- Table of Contents .....i
- Introduction..... 2
- Project History ..... 4
  - Project Overview ..... 4
  - Past Studies ..... 4
  - Summary..... 8
- Natural History ..... 9
  - California Newt ..... 9
  - Secondary Herpetofauna ..... 12
- Existing Site Conditions ..... 15
  - Environmental Setting ..... 15
  - Topography..... 15
  - Geology..... 15
  - Hydrology..... 17
  - Special-Status Species..... 19
  - Roadways..... 24
  - Land Ownership..... 26
  - Land Use..... 29
  - Recreational Amenities ..... 29
- Best Management Practices..... 31
  - Crossing System Performance Assessment ..... 31
  - Adaptive Management ..... 31
  - Crossing System Maintenance, Retrofitting, and Enhancement..... 31
  - Adjacent Functions and Uses ..... 32
- Crossings Design Guidance..... 33
  - Crossing Structure Design Types ..... 33
  - Crossing Structure Design Criteria and Variables..... 36
  - Barriers..... 36
  - Traffic Control and Calming..... 37
  - Additional Design Criteria..... 40
- Corrective Action Opportunities ..... 41
  - Stakeholder Involvement ..... 42
- References ..... 43

# Introduction



Since 2017, approximately 24,000 California newts (*Taricha torosa*) have been observed killed (dead on road) along Alma Bridge Road where it borders the east side of Lexington Reservoir in Santa Clara County, California (Newt Patrol 2022, Parsons 2022) (Figure 1). At an estimated road mortality rate for migratory newts of 39.2%, this local population may be under possible threat of extirpation (H.T. Harvey & Associates 2021). Midpeninsula Regional Open Space District (Midpen) and partner Santa Clara County, along with project stakeholders Valley Water and Peninsula Open Space Trust are looking to provide safe passage for California newts, rough-skinned newts (*T. granulosa*), and other herpetofauna species across Alma Bridge Road. This effort is collectively referred to as the Alma Bridge Road Newt Passage Project (Project).

This *Alma Bridge Road Newt Passage Project – Technical Review* (Technical Review) Memorandum provides a review of the Project history, the natural history of the California newt (as a proxy for the wider semiaquatic herpetofauna community present on site), existing site conditions as they relate to Alma Bridge Road as a dispersal and migration impediment between upland habitat and breeding habitat at Lexington Reservoir – including the environmental and physical setting, along with land ownership, land use and recreation, road crossing best management practices (BMPs), crossing design guidance, and corrective action opportunities. Collectively, this information will be used to better understand the constraints and opportunities posed by the current conditions at Alma Bridge Road, inform our understanding of existing newt natural history on site, and help identify environmental measures to accommodate future public access endeavors, including parking and trail connections on the Beatty property. The Technical Review will also help to establish the background against which any recommended or novel built or non-built “corrective actions” may be applied to decrease wildlife mortality and increase habitat permeability under subsequent Project tasks.

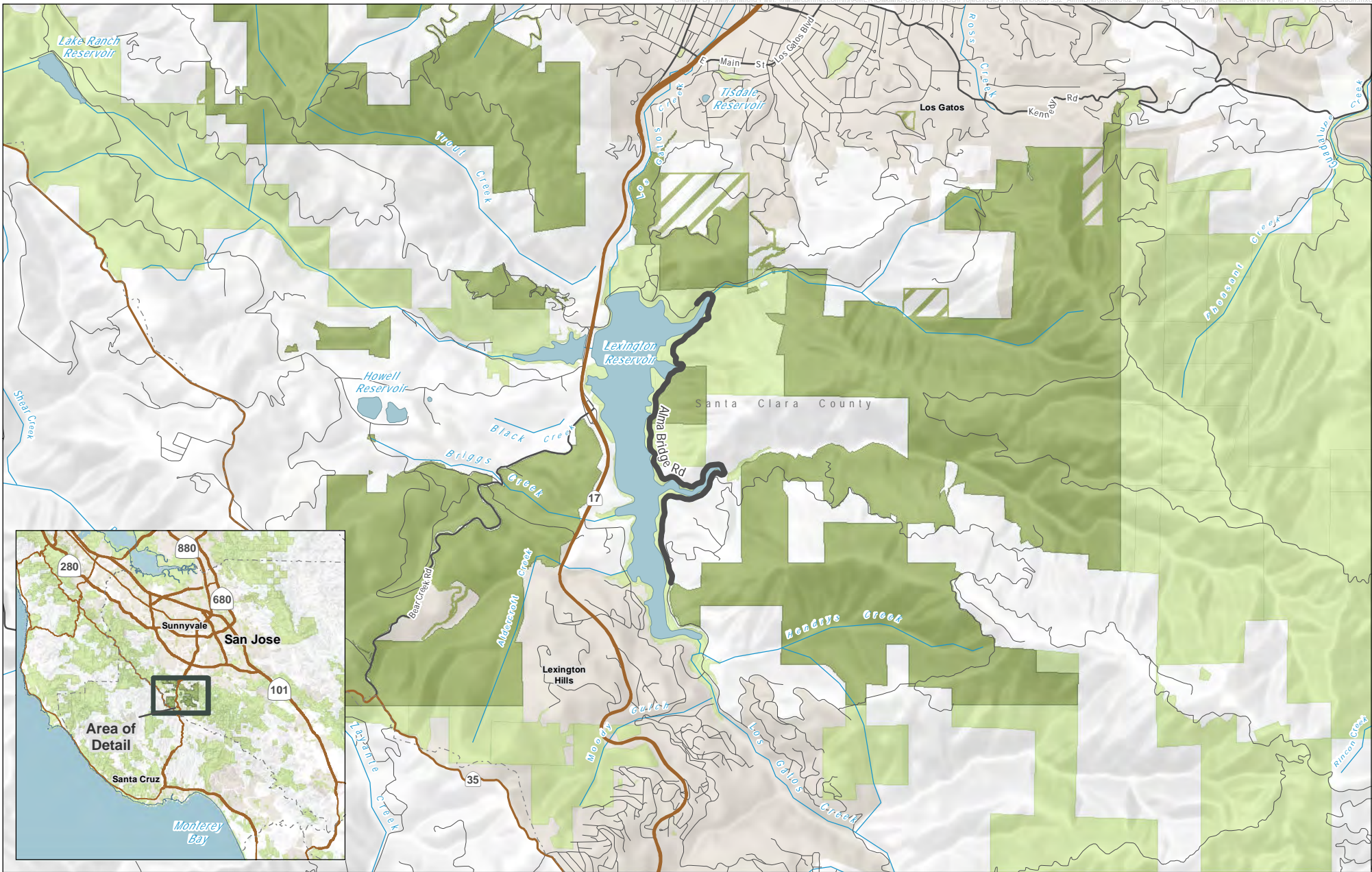
This Technical Review also provides a high-level review of past studies, road crossing BMPs, and crossing design guidance (Phase I) as they pertain specifically to this Project to help identify and recommend future corrective actions and feasibility analyses (Phase II and III). For a more exhaustive review of the topics discussed herein, we recommend that the reader reference the original source materials used to prepare this Technical Review (References).



**Figure 1: Project Location**

-  Study Area (along Alma Bridge Rd)
-  Midpen Open Access
-  Other Protected Land

Midpeninsula Regional  
Open Space District  
(Midpen)  
8/15/2022



While the District strives to use the best available digital data, these data do not represent a legal survey and are merely a graphic illustration of geographic features.

# Project History

## Project Overview

The effects of vehicle traffic on a local population of Pacific newts (genus *Taricha*) were first reported in November 2017 when a Midpen volunteer observed 42 dead newts along a short section of Alma Bridge Road (Figure 1) when accessing the area for other purposes. During a follow-up visit to Alma Bridge Road in January 2018, she recorded 417 newt carcasses along a 1.7-mile stretch of the roadway. As a result of these observations, she independently initiated a community science effort to document the full extent of newt mortality through formation of the Newt Patrol volunteer group, which uses iNaturalist to record and share all data (Parsons 2021, Newt Patrol 2022). The results of these surveys strongly suggested California newts were being killed in large quantities while crossing Alma Bridge Road during their annual breeding migration (Parsons 2021). At the behest of the Peninsula Open Space Trust (POST) working with the Project Partners, environmental consulting firm H.T. Harvey & Associates was contracted to perform standardized trapping surveys and modeling to determine to what degree the effects this level of mortality may have on the local population.

These studies—and the contributions of numerous stakeholders and technical experts—are integral to understanding the scope of mortality stemming from newt migrations to and from Lexington Reservoir. Using these findings, Midpen and Project Partners seek to identify and implement potential corrective actions to provide safe passage for California newts, rough-skinned newts, and other semiaquatic species that traverse Alma Bridge Road and utilize the surrounding watershed, including the reservoir, creeks, drainages, and associated uplands.

## Past Studies

### Pacific Newt Roadkill iNaturalist Project (Parsons 2021 and 2022)

The [Pacific Newt Roadkill iNaturalist Project \(Newt Patrol\) at Lexington Reservoir](#) is an ongoing community science effort founded in 2017 by Anne Parsons and currently led by Merav Vonshak, Ph.D. that uses iNaturalist as a data collection platform to quantify Pacific newt road mortality along Alma Bridge Road (Parsons 2021; Newt Patrol 2022). Under Merav's leadership, *in situ* data are collected by community members called the Newt Patrol. Through this research, they are also investigating how rain and carcass persistence, among other variables, might contribute to migration patterns and data collection quality, respectively, as well as how these factors may influence the understanding of newt mortality at Alma Bridge Road (Parsons 2021).

In brief, Newt Patrol volunteers record observations of dead and live newts, as well as non-newt carcasses, in iNaturalist with location data and photographs (Parsons 2021). With permission from the California Department of Fish and Wildlife (CDFW), volunteers remove newts from the road after data collection to avoid double counting. Observers also collect traffic data. This data is combined with local weather station data to analyze the relationship between newt roadkill and environmental parameters (Parsons 2021).

The documented 23,813 newt mortalities (as of September 1, 2022) along Alma Bridge Road over the course of five winter seasons (2017/2018 through 2021/2022) (Parsons 2022) (see Table 1 for details). Parsons (2021) reported that over a multiyear period, newt mortality was greatest in December (3,113), January (5,313), February (3,694), and March (2,864), with fewer mortalities at the beginning and end of the winter season in November (150), April (421), and May (26). These values represent the combined mortality observed between 2017 and 2021 by the Newt Patrol and H.T. Harvey in 2021 (see study described below).

The Pacific Newt Roadkill iNaturalist Project also observed high newt mortality on days when there had been no rain for three previous days; specifically, newt mortality during dry conditions was high across the three years when precipitation was monitored in 2018-19 (41.9%), 2019-20 (50.6%), 2020-21 (65.2%) (Parsons 2021). This suggests the conventional understanding that after the first rain, newts only migrate during wet conditions may vary by locality (Auza 1969). Ambient humidity may also play an understudied role (Parsons 2021).

According to volunteer observations and previous studies, most newt carcasses, but especially those of juveniles (Parsons 2021) persist for only hours or days on a road. Carcasses may be removed by scavengers, destroyed to the point of being undetectable, dissolved in wet conditions, or blown away by traffic or wind in dry weather (Santos et al. 2011, Parsons 2021).

**Table 1: Observed Newt Roadkill along Alma Bridge Road  
 (Pacific Newt Roadkill Project – Lexington Reservoir)**

Season	Observed Pacific Newt Roadkill <sup>1</sup>
2017 – 2018	471 <sup>2</sup>
2018 – 2019	4,892
2019 – 2020	5,294
2020 – 2021	4,941
2021 – 2022	8,215
<b>Total                      (as of end of 2021/2022                      season)<sup>3</sup></b>	<b>23,813</b>
<sup>1</sup> Pacific newts include California newt ( <i>T. torosa</i> ) and rough-skinned newt ( <i>T. granulosa</i> ). <sup>2</sup> Fewer surveys were conducted in 2017 – 2018, prior to the inception of the large volunteer effort. <sup>3</sup> The 2021/2022 season included observations from October 25,2021 through August 12, 2022 Source: <a href="https://www.inaturalist.org/projects/pacific-newt-roadkill-main-project-lexington-reservoir">https://www.inaturalist.org/projects/pacific-newt-roadkill-main-project-lexington-reservoir</a> as of conclusion of 2021/2022 Season.	

The Pacific Newt Roadkill iNaturalist Project also identified other roads in Santa Clara County with high newt mortality: Limekiln Canyon Road, Soda Springs Road, Montevina Road (west side of Highway 17), Hicks Road (along Guadalupe Reservoir), and Gilroy Hot Springs Road (Henry Coe State Park). These locations could serve as comparison sites or may be suitable locations for future studies and potential corrective actions, after the completion of this Project and the implementation of a performance assessment to evaluate the effectiveness of this Project’s corrective actions.

**Alma Bridge Road-Related Newt Mortality Study (H.T. Harvey & Associates 2021)**

H.T. Harvey & Associates’ Alma Bridge Road-Related Newt Mortality Study consisted of additional field surveys and various analyses looking at newt road mortality along Alma Bridge Road. The report describes the results of standardized drift fence/pitfall trap surveys during the 2020/2021 breeding season, mapping of newt mortality hotspots (2018/2019 breeding season, Figure 2a) based on iNaturalist data and mortality density (2020/2021 breeding season, Figure 2b) based on iNaturalist data and drift fence surveys, and population growth models under different mortality scenarios (H.T. Harvey & Associates 2021).

The H.T. Harvey & Associates 2020/2021 breeding season drift fence/pitfall trap surveys found a positive correlation between rain events and newt movement, and found that after the first rain event, a majority of the newts up until mid-December were shown to be traveling away from the reservoir, while those from December into February were shown to be traveling toward the reservoir (H.T. Harvey & Associates 2021).

In combining H.T. Harvey’s and the Pacific Newt Roadkill Project’s iNaturalist datasets, H.T. Harvey determined that the local newt population experienced an overall 39.2% road-based mortality rate during the 2020/2021 migrations to and from Lexington Reservoir (H.T. Harvey & Associates 2021).

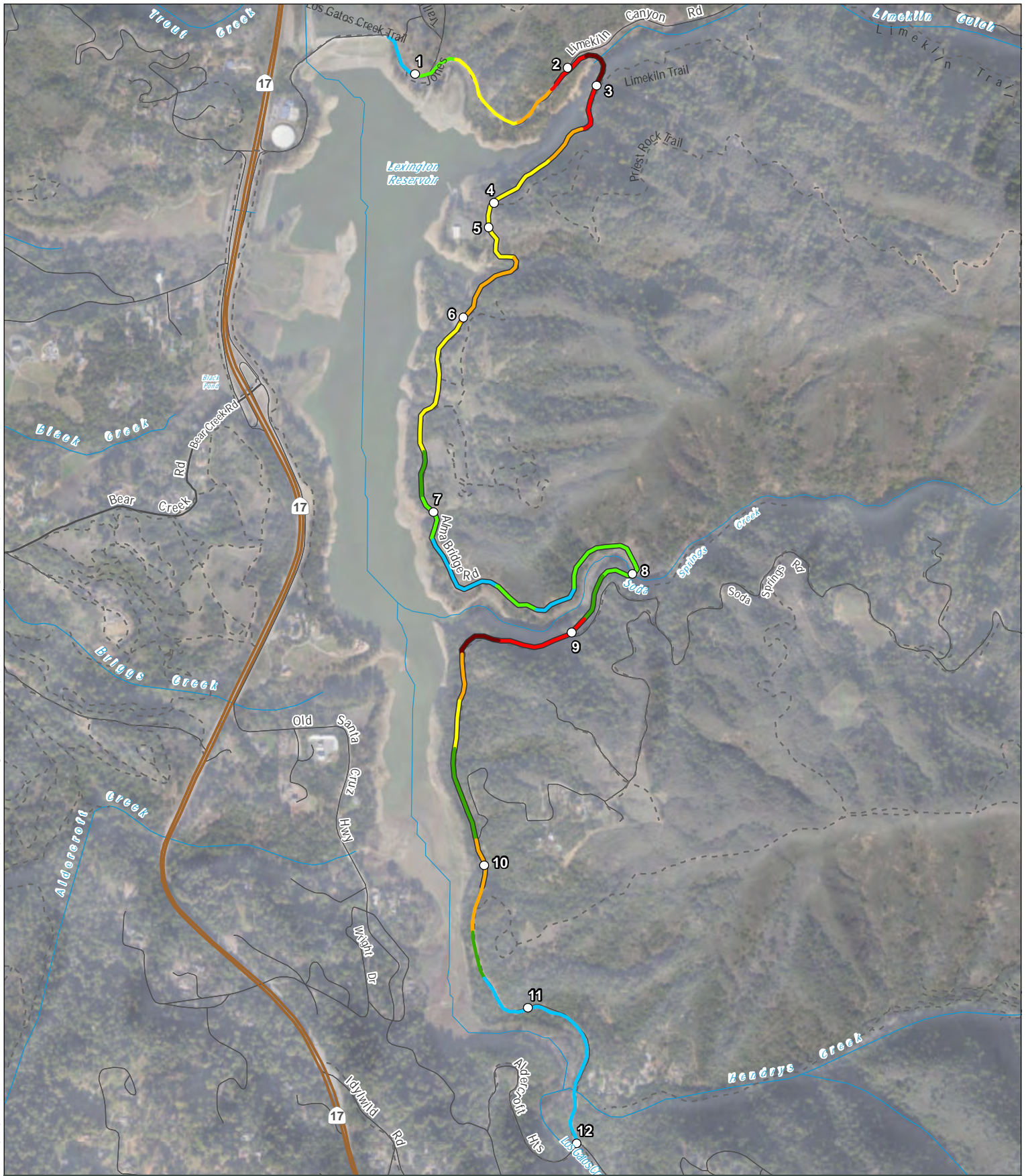

Created By: sally.shah@midpen.org Path: \\na.aecomnet.com\ms\AMER\Oakland-US\QAR\01\DCS\Projects\GIS\Projects\60887532\_AlmaBridgeRoad\02\_Map\02\_Report\_Map\Technical Review\Figure 2\_NewMortality\_Hotspots.mxd

**Figure 2a: Newt Mortality Hotspots (Standardized by Effort)**

- |                       |                          |                                    |  |
|-----------------------|--------------------------|------------------------------------|--|
| — Alma Bridge Rd      | — Medium High            | 2. Lexington Quarry                | 8. Water Co. Facility in Soda Springs Canyon |
| - - - Existing Trail  | — Medium                 | 3. Limekin Trailhead               | 9. Soda Springs Rd.                          |
| <b>Newt Mortality</b> | — Low                    | 4. Priest Rock Trailhead           | 10. White House - Private Residence          |
| — Extremely High      | — Very Low               | 5. Los Gatos Rowing Club           | 11. RIP Cross                                |
| — Very High           | ○ Road Features          | 6. Douglas B. Miller Memorial Park | 12. Aldercroft Heights Rd.                   |
| — High                | 1. St. Joseph's Hill OSP | 7. Stop Sign                       |  |

Midpeninsula Regional  
Open Space District  
(Midpen)  
8/17/2022



While the District strives to use the best available digital data, these data do not represent a legal survey and are merely a graphic illustration of geographic features.

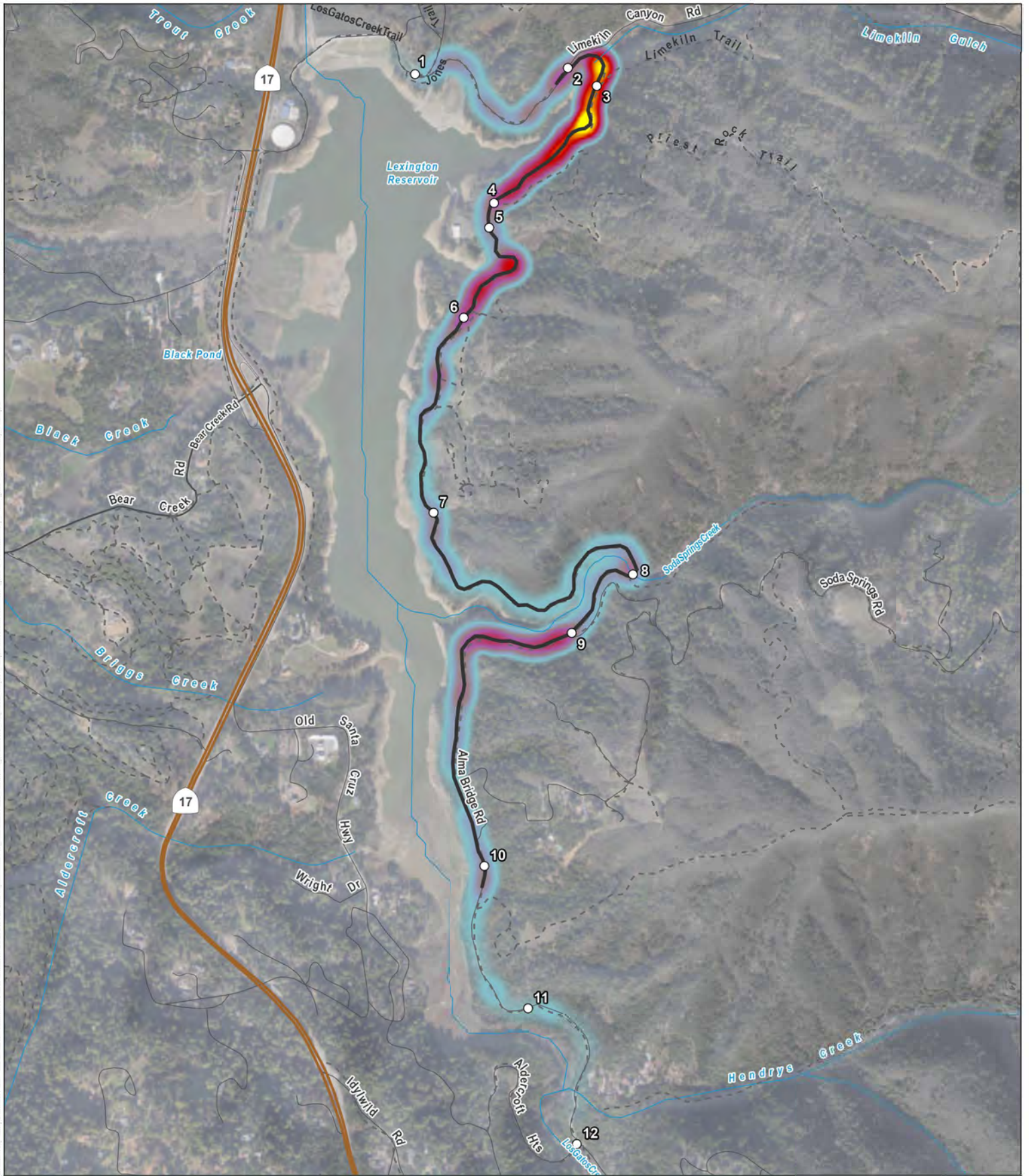

**Figure 2b: Newt Mortality Density**

- Alma Bridge Rd
- - - Existing Trail
- Newt Fatality Observations**
- Sparse to Dense
- Road Features
- 1. St. Joseph's Hill OSP
- 2. Lexington Quarry
- 3. Limekiln Trailhead
- 4. Priest Rock Trailhead
- 5. Los Gatos Rowing Club
- 6. Douglas B. Miller Memorial Park
- 7. Stop Sign
- 8. Water Co. Facility in Soda Springs Canyon
- 9. Soda Springs Rd.
- 10. White House - Private Residence
- 11. RIP Cross
- 12. Aldercroft Heights Rd.

Midpeninsula Regional  
Open Space District  
(Midpen)  
8/19/2022



While the District strives to use the best available digital data, these data do not represent a legal survey and are merely a graphic illustration of geographic features.



**Population Growth Model (H.T. Harvey & Associates 2021)**

In addition to the mortality study, H.T. Harvey & Associates also developed a population growth model based on the calculated 39.2% road-based mortality rate, average clutch size (number of eggs laid by a breeding female), and survival rate at each life stage.

Based on these parameters, the population growth model predicts that if the 39.2% road-based mortality continues unabated, this population may possibly become extirpated in approximately 57 years (i.e. ~2079) (H.T. Harvey & Associates 2021). Reducing road-based mortality to between 17.667% and 20% would allow the population to persist beyond 200 years, but the population would slowly decline. However, assuming the model inputs are correct, reducing the mortality rate to 17.667% or less (an approximately 45% reduction from current levels) would sustain the population at its current size beyond 200 years (H.T. Harvey & Associates 2021).

**Summary**

Combined, these studies present the best available science on the seasonal migratory behavior of California newt in the region. In short, Pacific Newt Roadkill Project data suggest that seasonal migrations begin with the first substantial rain in November and end in May, with peak movement activities taking place during December, January, February, and March. Equally important was the observation that while H.T. Harvey & Associates (2021) found a positive correlation between rain events and migratory movement, Parsons (2021) data showed that nearly half of all newt mortality took place on dry nights with no preceding rain event. While a rain event of approximately one inch will likely initiate Lexington Reservoir newt migrations, ongoing rains are not necessary to facilitate the rest of the migration. As such, seasonal migratory movement and associated road mortality might not necessarily coincide with rain events in this population. Other environmental factors, such as humidity, may play an important role in driving movement.

Similarly, the Alma Bridge Road-Related Newt Mortality Study identified road mortality hotspots based on 2018/2019 and 2020/2021 breeding season data that can be used to prioritize the placement of corrective actions. The study also calculated the rate of road-based mortality rate (39.2%) and determined the reduced road mortality rate (17.667%) that would be necessary for the population to persist at its current size. Presumably, any further reduction in the road-based mortality rate beyond 17.667% is expected to further help the population.

Together, these studies quantify the need for corrective actions to simultaneously decrease wildlife mortality and increase wildlife movement permeability along and across Alma Bridge Road.

# Natural History

For the purposes of this Technical Review, the California newt has been selected as a proxy for the herpetofauna assemblage present on site. A review of this species' natural history is provided below to understand its habitat requirements and movement patterns in the context of the Project to help identify and inform feasibility analyses and future corrective actions. In addition, the natural history of five amphibian and one reptile species are discussed briefly below due to their prevalence on site or state and federal listing status to inform future permitting recommendations and CEQA review for the Project, if necessary.

## California Newt

The California newt is a medium-sized western salamander with a widespread range that extends from Mendocino County, through the San Francisco Bay Area and down the coastal mountain ranges to southern California, with an isolated population in the southern Sierra Nevada mountain range. It occurs from sea level to 4,200 feet elevation. The California newt is in the genus *Taricha*, which includes four species of toxic newts in the family Salamandridae, referred to as Pacific newts. Three species of *Taricha* are found in and around the San Francisco Bay Area: the California newt (*T. torosa*), the rough-skinned newt (*T. granulosa*), and the red-bellied newt (*T. rivularis*). The fourth is the Sierra newt, which occurs in the Sierra Nevada Mountains (*T. sierrae*). *Taricha* are characterized by their brown dorsal and bright yellow or orange ventral coloration, signaling the highly poisonous nature of the newt's tetrodotoxin skin secretions (Storer 1925, Stebbins and McGinnis 2012).

Through a risk prioritization assessment of California's amphibians and reptiles looking at risk of extirpation from road-related impacts, Caltrans identified California newt as a Very-High Risk species (Brehme and Fisher 2021).

### Habitat

The California newt is closely associated with woodland habitats, including those interspersed with grassland and chaparral. They can also be found in grasslands, wet forests, and even pure chaparral habitats in southern California. In the San Francisco Bay Area, the species most often inhabits coast live oak woodlands (Stebbins and McGinnis 2012). California newts require suitable breeding habitat within two miles of upland habitat (Trenham 1998).

California newts require nearby streams, ponds, lakes, or reservoirs to breed. Ideal water sources for breeding often have rocky bottoms and egg mass attachment sites in the form of emergent vegetation, exposed tree roots, and woody debris. These also function as refugia from predators, principally various garter snake species resistant to the newt's tetrodotoxin, as well as introduced crayfish and American bullfrogs (Stebbins and McGinnis 2012).

### Diet

Adult California newt prey upon a diverse assemblage of small terrestrial and aquatic invertebrates, such as earthworms, insects, and crustaceans (Stebbins and McGinnis 2012). Notably, adults will also often feed on the eggs of fish and other amphibians, such as the federally listed California red-legged frog (*Rana draytonii*) and steelhead trout (*Oncorhynchus mykiss*) (Zeiner et al. 1988). While in the larval life stage, their generalist diet consists of several types of insect larvae, decomposing organic matter, and scavenged animal matter (Stebbins and McGinnis 2012).

### Breeding

California newt breeding occurs between December and May, though females may not breed every year if their breeding is similar to that of the red-bellied newt (Twitty 1961, Twitty 1964, Kuchta 2005, Stebbins and McGinnis 2012). In both cases, males arrive to breeding sites several days to weeks earlier and remain there longer (Ritter 1897, Miller and Robbins 1954, Pimental 1960, Auza 1969). As they await the arrival of females, males transition to their aquatic form, adopting smoother skin and larger, flatter tails more suitable for swimming, among other traits to aid in aquatic movement and amplexus (Auza 1969, Storer 1925). Females

develop smooth skin as well but lack the other seasonal changes. Copulation occurs through amplexus, with 'newt balls' or 'newt clusters' sometimes forming when several males compete for relatively few females (Auza 1969). Females lay an average of 3 to 6 egg masses (Brame 1968). Following fertilization, gelatinous egg masses containing 7-39 ova are attached to emergent vegetation, exposed riparian tree roots, or alluvium (Stebbins and McGinnis 2012).

Eggs hatch after 5-10 weeks (Auza 1969), and larval newts will remain in their natal water source for 3-6 months on average from March on into October prior to emergence (Ritter 1897). This can vary with water temperature and food availability (Kuchta 2005, Stebbins and McGinnis 2012). Their average length at metamorphosis is 47 mm (Ritter 1897). Figure 3 shows the months these breeding behaviors typically occur.

**Figure 3.** Typical Timing of Seasonal Newt Migration, Breeding, and Post-Dispersal Behavior

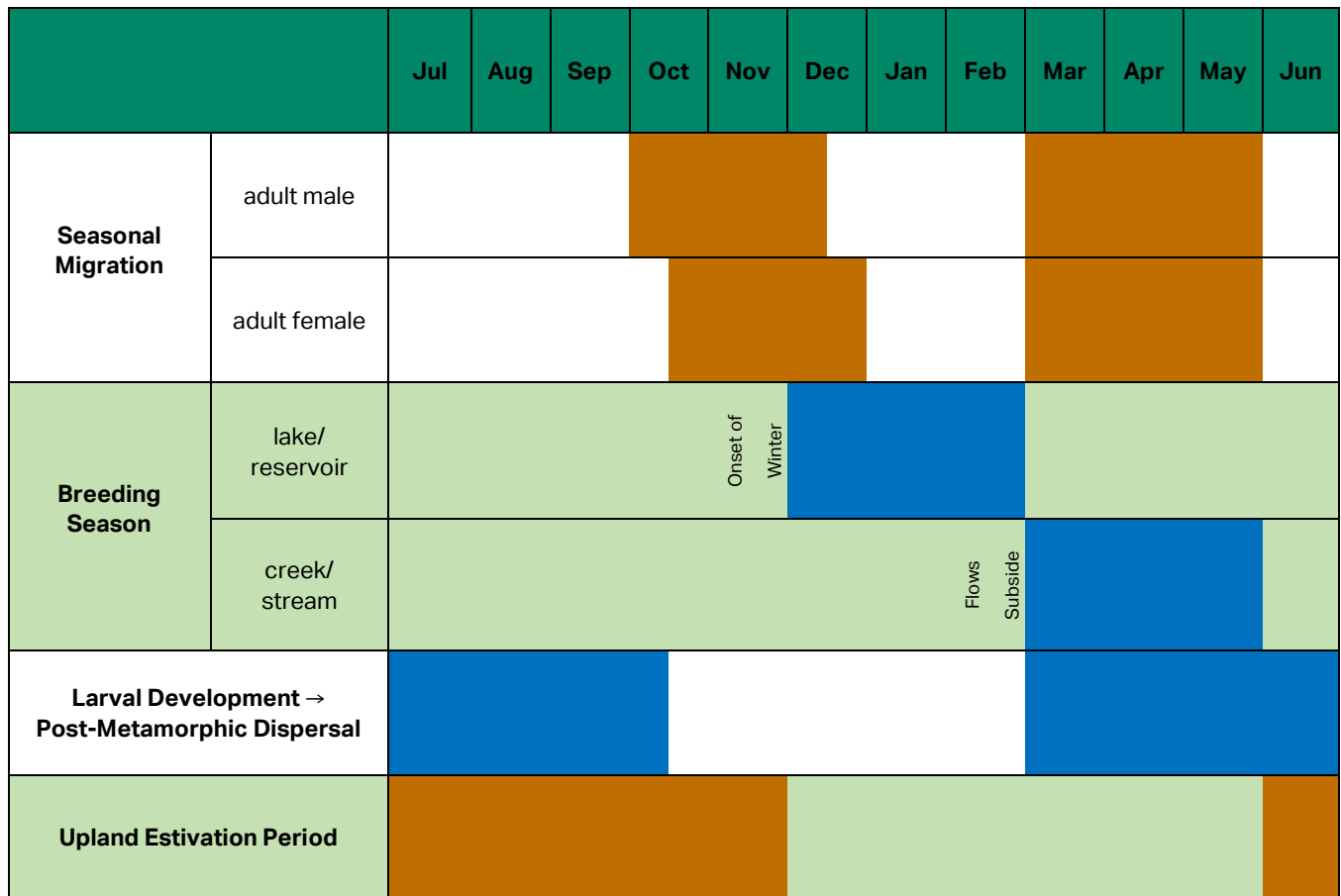

Brown = Life cycle stage that is primarily terrestrial; Blue = Life cycle stage that is primarily aquatic

**Seasonal Migration and Post-Metamorphic Dispersal**

While relatively quick and agile in water, especially in their aquatic form, California newts move slowly on land. This makes them vulnerable to vehicle collisions when migratory paths cross roadways (Storer 1925). Their slow ambulation style also means long distance overland travel can take considerable time and effort (Auza 1969, Miller and Robbins 1954). At present, neither vertical slopes nor vertical barriers are believed to present total topographic limitation to adult newt and salamander movement, and wet conditions may facilitate vertical travel by means of wet adhesion with a substrate. However, a negative gradient or overhang (see discussion of overhangs in Height, below) can obstruct movement by introducing a negative gradient. Likewise, during the traverse of a vertical to near-vertical slope over increasing distance (=height), individuals might succumb to losing their grip and falling (more so in adults than juveniles) (Thomas Langton, personal communication, 2022).

California newts perform two discrete types of migrations, adult seasonal breeding migrations (to and from the water body) and juvenile post-metamorphic dispersal (away from the water body). In the related *T. granulosa*, Pimental (1960) describes four movement types: "sporadic" – the non-directional movement that takes place in response to the first winter rains, "pond entrance" – the directional movement from upland to breeding habitat, "wandering" – another non-direction movement to- and from- a pond during the breeding period, and "pond exit" – the directional movement from breeding habitat to upland. Seasonal migrations allow adult newts to congregate at breeding waters and then depart for suitable terrestrial estivation habitat upon cessation of their breeding season (Storer 1925, Stebbins and McGinnis 2012). Among the directional cues newts may use to locate breeding sites, in the related *T. granulosa*, Pimental (1960) suggests that following a downhill slope may be instrumental for newt movement.

Seasonal migrations are typically triggered by the first heavy autumnal rains of at least 1 inch (Claggett 1989, Kuchta 2005, H.T. Harvey & Associates 2021). Temperature drops may also be a contributing factor (Auza 1969). In addition to triggering hormonal changes that signal the drive to breed, these environmental cues facilitate the creation of suitably wet corridors for overland travel (Auza 1969). Migrations in and out of breeding ponds may be *en masse* or individual (Storer 1925). Olfaction and kinesthetic sense likely play key roles in orientation during migration events, especially given that individuals return to the same pond to breed (Auza 1969, Endler 1970). Newts may also reject migratory routes without natural light or artificial light that simulates natural light levels and patterns at night (FHWA 2011, Brehme and Fisher 2021).

In general, because the species prefers to migrate in wet conditions, migration timing may also vary year to year with environmental conditions (Auza 1969). Migratory movement toward breeding habitat has been recorded from October through March at Briones Reservoir (Endler 1970), and mid-October through December (on into January and early February) in Palo Alto (Miller and Robbins 1954). Due to the newt's slow movement, primarily nocturnal activity, and long distances between terrestrial and aquatic habitats, seasonal migrations typically take 1-2 weeks, with one study suggesting the migration may require 6-8 weeks (Miller and Robbins 1954, Auza 1969, Trenham 1998). This timeframe is influenced by proximity to the breeding site, environmental conditions in a given year, and the terrain along the migration corridor (Auza 1969, Kuchta 2005).

Exact timing can vary, with some locations in Berkeley, Palo Alto, and Santa Clara County exhibiting two separate groups that breed on either the early (December through March) or late (March through May) ends of the season (Twitty 1942, Brame 1968, Kuchta 2005). Twitty (1942) observed that this timing correlates with the type of breeding waters. Ponds and reservoirs (such as Lexington Reservoir) are more frequently used by earlier breeders. Later breeders, on the other hand, tend to breed in creeks following the conclusion of winter floods (Twitty 1942). Adult newts' seasonal migration out of ponds and other breeding sites is greatest in March and April when conditions are still moist, and continuing into May (Auza 1969). However, adults have been observed departing as early as immediately after spawning and as late as May (Storer 1925, Kuchta 2005). This migration back to terrestrial habitat varies greatly by geography, weather conditions, and the hydroperiod of the wetland (Kuchta 2005).

Given these two seasonal ecotypes recognized amongst California newts, newts inhabiting the Los Gatos Creek watershed prior to the construction of Lexington Reservoir and the impoundment of Los Gatos Creek in 1952 would likely have exhibited migratory movements timed in response to receding winter flows in the then-intact creek systems. At present, however, migratory movements post-Lexington Reservoir appear more in sync with winter rains. Storer (1925) observed that permanent water bodies such as ponds and reservoirs were historically uncommon on the original California landscape, and that the species' prolonged period of larval development may have limited their presence to permanent or ephemeral waters that persist through the summer months, like ponds or deep pools along creek. At Alma Bridge Road, any ambiguity in seasonal migratory movement timing or 'triggers' may reflect a learned or environment-induced shift in behavioral response to environmental cues brought on by the modifications of flow of Los Gatos Creek and other nearby creeks as a result of human settlement in the area over the past 70+ years.

During post-metamorphic dispersal, newly emerging newts leave the water and seek safe terrestrial habitat to forage, estivate, and reach sexual maturity (Storer 1925, Auza 1969). California newts disperse from their natal breeding sites following metamorphosis. This subsequent dispersal occurs between the end of the first summer and following summer, depending on the wetland's hydroperiod (Auza 1969). During post-metamorphic dispersal, as well as adult spring emigration from breeding waters, California newts may travel as far as two miles from natal or breeding water sources to find suitable habitat (Trenham 1998).

Metamorphosed newts, having developed terrestrial features, typically emigrate from their breeding site between late summer and fall (Auza 1969, Kuchta 2005, Parsons 2021). They seek suitable terrestrial habitats where they remain for at least two years, typically three years, until they reach sexual maturity (Storer 1925, Auza 1969). Once sexually mature, they migrate as adults to their natal waters or other nearby water sources to breed (Auza 1969, Kuchta 2005). Upon identification of a suitable breeding site, newts will use their kinesthetic sense to return to the same breeding site each year (Endler 1970, Kuchta 2005). After breeding, some adults remain year-round in permanent water sources, while others leave once spawning is complete. Both behaviors have been observed in San Francisco Bay Area populations (Storer 1925). Adults return during the latter half of the wet season to nearby upland habitats where they are most active at night, relying on their rough skin as protection against desiccation (Storer 1925, Auza 1969). In the dry summer months, California newts will seek cooler, wetter microclimates such as moist leaf litter, rocks in dry creek beds, woody debris in shaded forests, and small mammal burrows to estivate until the first rains of fall arrive (Auza 1969, Kuchta 2005).

### **Behavioral Response to Perceived Danger to Traffic**

Jacobson et al. (2016) identified four risk-avoidance behavioral responses in wildlife based on the perceived danger to traffic: nonresponders, pausers, speeders, and avoiders. Nonresponders do not recognize moving traffic as a threat and will attempt to cross highways regardless of traffic volume. Pausers respond to a perceived risk and will stop in the face of danger by reducing speed or freezing. Speeders can recognize a threat and exhibit a primary response consisting of flight. Avoiders can also recognize a threat and respond by avoiding traffic and roadways.

California and rough-skinned newt risk-avoidance behavior likely ranges between a nonresponder (when a threat catches them off-guard) and a pauser (when an imminent threat is perceived). Parsons (2021) reports both *T. torosa* and *T. granulosa* exhibiting signs of the defensive posture known as the Unken reflex, suggesting the individuals may have been aware of an oncoming threat before they were killed by vehicle traffic along Alma Bridge Road. As both a nonresponder and a pauser, however, the barrier effects to California newts posed by a county road such as Alma Bridge Road are primarily due to road mortality as a result of vehicle traffic.

## **Secondary Herpetofauna**

In addition to the California newt, several additional key, predominantly special-status, amphibian and one reptile species representing the assemblage of secondary herpetofauna are discussed briefly below. The species accounts represent only a portion of the amphibian and reptile species present on the site.

### **Santa Cruz Black Salamander**

The Santa Cruz black salamander (*Aneides flavipunctatus niger*), a California Species of Special Concern, is a medium-sized terrestrial salamander endemic to California whose range is restricted to the woodlands of the Santa Cruz Mountains in western Santa Clara, northern Santa Cruz, and southernmost San Mateo Counties. This species is active during the night year-round, especially in response to rain events. Eggs are deposited belowground between July and August, and juveniles emerge from belowground after fall rains in October or November. Habitat requirements include mesic forests in the fog belt of the Outer Coast Range, and moist streamside microhabitats that include shallow standing water or seeps, under stones and boards, and in talus formations or rock rubble (Thomson et al. 2016). Caltrans has identified Santa Cruz black salamander as a Very-Low Risk species for road related impacts; this is primarily because the species does not perform breeding migrations like newts that would expose it to roads (Brehme and Fisher 2021).

The Santa Cruz black salamander is known from locations around Lexington Reservoir, including Hendry's Creek and the Soda Springs Canyon watershed (CDFW 2022) and three individuals have been recorded dead on Alma Bridge Road during recent road mortality studies (H.T. Harvey & Associates 2021).

### **California Giant Salamander**

The California giant salamander (*Dicamptodon ensatus*), a California Species of Special Concern, is a large terrestrial salamander endemic to California whose range is restricted to mesic coastal forests in the Coast Ranges (southern Mendocino and Marin Counties), inner Coast Ranges (Napa County, Sonoma, Lake, and Solano Counties), and Santa Cruz Mountains (San Mateo, Santa Clara, and Santa Cruz Counties). This species moves between terrestrial and stream habitats during the fall rainy season. Habitat requirements include oak woodland, coniferous forest, and coastal chaparral habitats with access to cold permanent and semi-permanent streams as habitat for breeding and larval development (Thomson et al. 2016). Caltrans has identified California giant salamander as a High-Risk species for road related impacts (Brehme and Fisher 2021).

The California giant salamander is known from limited locations around Lexington Reservoir, including Hendry's Creek (CDFW 2022), but has not been reported during recent road mortality studies (H.T. Harvey & Associates 2021, Parsons 2021).

### **Rough-Skinned Newt**

The rough-skinned newt (*Taricha granulosa*) is a medium-sized western salamander with a widespread range that includes the humid coast from southeast Alaska to southern Santa Cruz County and portions of the Sierra Nevada foothills. This species is active throughout the year, and is commonly found moving aboveground, often in response to rain events. Breeding takes place between late December and July in ponds, lakes, reservoirs, and slow-moving streams. Habitat requirements include grasslands, woodlands, and forests (Stebbins 2003). Caltrans has identified rough-skinned newt as a High-Risk species for road related impacts (Brehme and Fisher 2021).

The rough-skinned newt is known from locations throughout the Lexington Reservoir watershed and has been recorded on site during recent road mortality studies (H.T. Harvey & Associates 2021, Parsons 2021).

### **Foothill Yellow-Legged Frog**

The foothill yellow-legged frog (*Rana boylei*), a California State Endangered Species, is a medium-sized, highly aquatic stream-dwelling frog whose range includes foothill and mountain streams between southern Oregon and Los Angeles County. This species is strictly aquatic, ranging no further than 3.0 to 40 m (10 to 131 ft.) upland from water on occasion. Habitat requirements include shallow, flowing water characterized by cobble (augmented by gravel and boulder) substrates. Eggs are deposited under or behind rocks in low-flow areas in the Spring after flood waters recede (Thomson et al. 2016). Caltrans has identified foothill yellow-legged frog as a Medium Risk species for road related impacts (Brehme and Fisher 2021).

The foothill yellow-legged frog was historically present at scattered locations throughout the Lexington Reservoir Watershed (i.e. Hendry's Creek), but at present is considered locally extirpated (CDFW 2022). This species has not been reported during recent road mortality studies (H.T. Harvey & Associates 2021, Parsons 2021) and is unlikely to be present on site.

### **California Red-Legged Frog**

The California red-legged frog (*Rana draytonii*), a Federally Threatened species and a California Species of Special Concern, is a large frog endemic to California whose range includes slow-flowing streams, marshes, lagoons, ponds, and pools with permanent water from the Sierra Nevada foothills and Coast Range mountains southward to Baja California. Habitat requirements include dense riparian vegetation, slow moving water, emergent vegetation, and upland refugia habitat. Breeding takes place between November and April (Thompson et al. 2016). Caltrans has identified California red-legged frog as Very High-Risk species for road related impacts (Brehme and Fisher 2021).

The California red-legged frog was historically present at Lexington Reservoir and upstream portions of Los Gatos Creek, but these records date to 1956 and 1987, respectively (CDFW 2022). The species faces competition from and predation by the invasive American bullfrog, as well as non-native bass, which are present in Lexington Reservoir. California red-legged frog individuals have not been reported during recent road mortality studies (H.T. Harvey & Associates 2021, Parsons 2021).

### **Southwestern Pond Turtle**

The southwestern pond turtle (*Actinemys pallida*), a California Species of Special Concern, is the only freshwater turtle native to California. The species is currently under 12-month review for Federal Endangered Species Act listing. Their range includes natural and human-made waterbodies and surrounding uplands. Adults are active year-round, and although the species is primarily aquatic, western pond turtles use upland habitat to nest (females), seek mates, disperse, overwinter, or escape drought conditions. Females will venture anywhere from 3 to over 402 m (9.8 to 1,319 ft) from a waterbody to find suitable nesting habitat. Habitat requirements include slow-moving waterbodies, aquatic refugia (i.e. undercut banks; submerged vegetation, rocks, or logs), and typically south- or west-facing slopes characterized by sparse vegetation and hard-packed soils (Bury et al. 2021). Caltrans has identified western pond turtle as a Very High-Risk species for road related impacts (Brehme and Fisher 2021).

The western pond turtle is known from limited locations around Lexington Reservoir (CDFW 2022), but has not been reported during recent road mortality studies (H.T. Harvey & Associates 2021, Parsons 2021).

# Existing Site Conditions

## Environmental Setting

The Project is located along Alma Bridge Road in Santa Clara County, California, and is geographically situated in the foothills of the Santa Cruz Mountains south of the incorporated town of Los Gatos, north of the unincorporated area of Lexington Hills, and primarily extends along the eastern shore of Lexington Reservoir (Figure 1). In the public land survey system, the study area is depicted on the Los Gatos 7.5-minute USGS topographic quadrangle. The land surrounding the Project area can be characterized as a combination of primarily open space intermixed with intermittent rural, rural residential, and limited commercial.

## Topography

The topography of the Project area is relatively steep, ranging from the Lexington Reservoir (roughly 625 ft) to Alma Bridge Road roadway (roughly 640 to 750 ft) to the top of the roadcut embankment east of Alma Bridge Road (roughly 660 to 780 ft) above mean sea level. The slopes above the roadway continue to rise in elevation up to 2,999 feet at the summit of Mount El Sombroso, located 4 miles to the east in the Sierra Azul Open Space Preserve.

The upslope embankment east of Alma Bridge Road varies between gentle (<15% slope) (infrequent) to steep (30% to 60% slope) (typical) and includes areas with sheer embankments ( $\geq 100\%$ ) ranging in height from an estimated two to eight feet to greater than eight feet in areas where the road parallels especially steep terrain. Downslope, the embankment west of Alma Bridge Road can be characterized similar to the upslope terrain, with the exception of an intermediary berm bordering the road shoulder separating the roadway and areas downslope. These artificial berms vary in height from estimated 0 to seven feet from the road deck.



## Geology

Mapping shows that the Project lies in a geologically complex area composed of Cretaceous age Franciscan complex rocks with extensive areas of Holocene and Pleistocene age alluvium, alluvial terrace deposits, and Santa Clara Formation bordering Lexington Reservoir (McLaughlin et al. 2001). Several earthquake faults exist in the Project vicinity, including the Berrocal, Lime Kiln, and Soda Spring fault zones to the north and northeast of Lexington Reservoir, and the San Andreas fault zone to the southwest (McLaughlin et al. 2001, USGS 2022b). Alma Bridge Road crosses the Lexington fault zone, which is mapped as a north-south series of faults along the eastern side of the reservoir. County mapping shows Los Gatos Creek to the north of Lexington Reservoir as a liquefaction hazard zone. Fault rupture hazard zones are associated with both the San Andreas fault and the Lexington fault, including all of Alma Bridge Road from just east of James J. Lenihan Dam to south of Soda Spring Creek. Most of the area surrounding Lexington Reservoir, including Alma Bridge Road, is identified as a landslide hazard zone (Santa Clara County Planning and Development 2022a).

## Soil Types

The majority of soils along Alma Bridge Road and the eastern side of Lexington Reservoir are mapped as Katykat-Mouser-Sanikara complex, 30 to 50 percent slopes (Figure 4). There are also areas of Sanikara-Rock Outcrop complex, 75 to 100 percent slopes, along Limekiln Canyon and Soda Spring Canyon; and Katykat-Sanikara complex, 8 to 30 percent slopes, along Alma Bridge Road near the southern edge of the reservoir (Santa Clara County Planning and Development 2022b). All are well-drained soils that occur in mountainous, hilly, and sloping terrain (Natural Resources Conservation Service 2019).



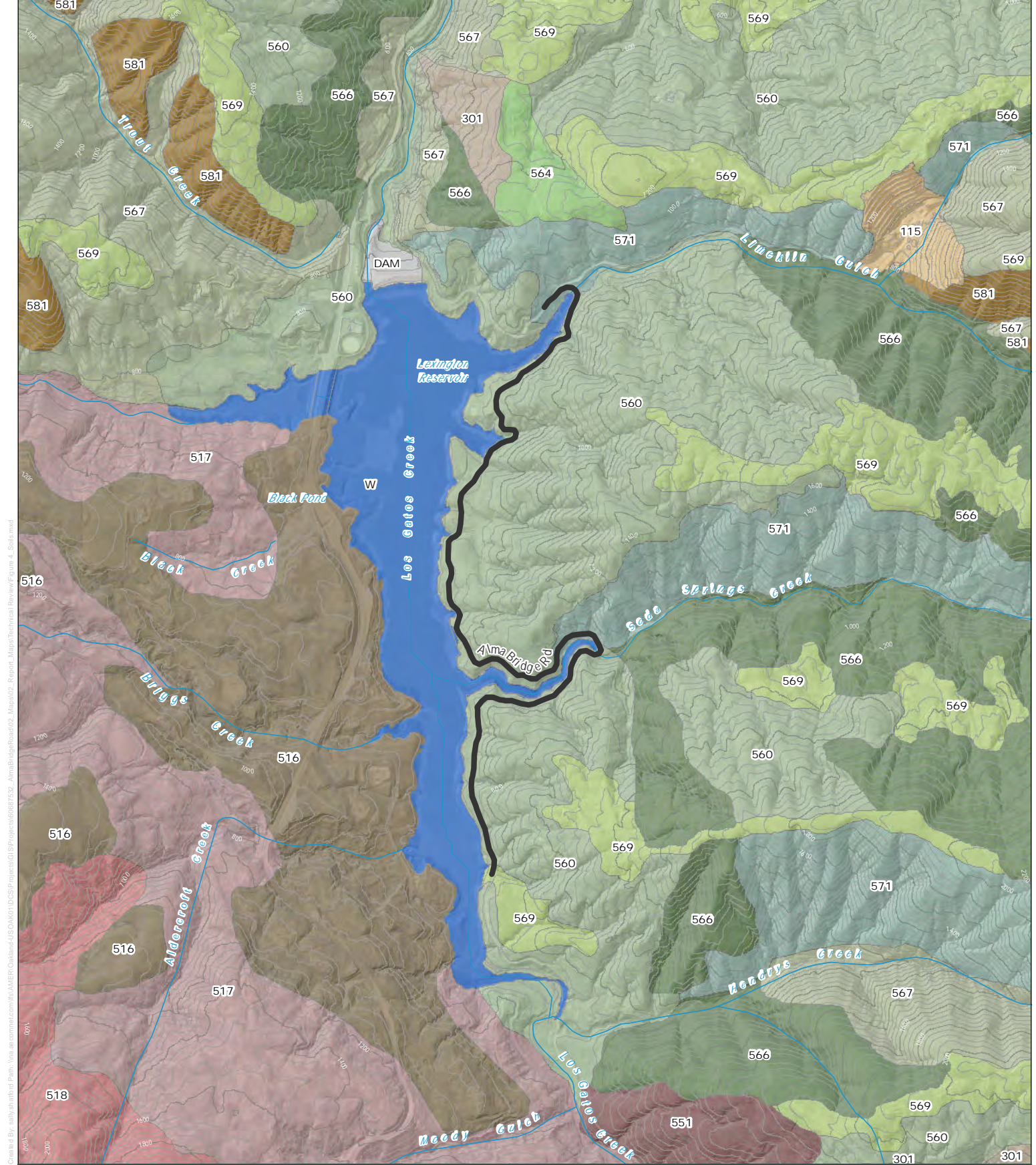

Created By: sally@midpen.org Path: \\na.aecomnet.com\GIS\AMER\Oakland-US\OAK01\DCS\Projects\GIS\Projects\61887532\_AlmaBridge\Road\02\_Maps\02\_Report\_Map\Technical Review\Figure 4\_Soils.mxd

**Figure 4: Soils**

Study Area (along Alma Bridge)

**SSURGO**

- 115: Pits, mine
- 301: Montara sandy loam, 15 to 50 percent slopes
- 516: Ben Lomond gravelly sandy loam, 15 to 30 percent slopes

- 517: Ben Lomond-Casrock complex, 30 to 50 percent slopes
- 518: Ben Lomond-Casrock complex, 50 to 75 percent slopes
- 551: Maymen-Katykat complex, 8 to 30 percent slopes
- 560: Katykat-Mouser-Sanikara complex, 30 to 50 percent slopes

- 564: Santerhill-Xerolls-Mouser complex, 15 to 30 percent slopes, mined land
- 566: Mouser-Katykat-Sanikara complex, 50 to 75 percent slopes
- 567: Sanikara-Mouser-Rock outcrop complex, 50 to 75 percent slopes
- 569: Katykat-Sanikara complex, 8 to 30 percent slopes

- 571: Sanikara-Rock Outcrop complex, 75 to 100 percent slopes
- 581: Maymen gravelly sandy clay loam, 50 to 75 percent slopes
- DAM: Large dams
- W: Water

Midpeninsula Regional  
Open Space District  
(Midpen)  
8/15/2022



While the District strives to use the best available digital data, these data do not represent a legal survey and are merely a graphic illustration of geographic features.

## Hydrology

Collectively, Los Gatos Creek and its feeder streams that cross Alma Bridge Road (Limekiln Canyon/Creek, Soda Springs Creek, Hendry's Creek), and the Lexington Reservoir, fall within the Guadalupe River-Frontal San Francisco Bay Estuaries (HUC 10 1805000303) Watershed and the Los Gatos Creek (HUC 12 180500030303) Watershed (Figure 5). Each of these aquatic features are described briefly, below. Hydrologic information was collated from the USGS National Map-National Hydrography dataset (USGS 2022a), USFWS National Wetlands Inventory Wetlands Mapper (USFWS 2022b), and Cowardin classifications (Cowardin et al. 1979).

### Los Gatos Creek

Los Gatos Creek is a perennial creek that flows south to north from Lake Elsmar to the Lexington Reservoir. After the construction of the Lexington Reservoir in 1952, Los Gatos Creek was bisected into two separate reaches: upper- and lower- Los Gatos Creek. Upstream of the reservoir, the upper reach of Los Gatos Creek extends 10.44 miles south-southeast. Downstream of the Lenihan Dam, the lower reach of Los Gatos Creek extends 11.78 miles north through the cities of Los Gatos, Campbell, and San Jose before its confluence with the Guadalupe River.

### Lexington Reservoir

The Lexington Reservoir, a 338-acre artificial lake formed by the 195 ft earthen James J. Lenihan Dam (Lenihan Dam), was constructed and completed in 1952 on Los Gatos Creek. The reservoir is located in Lexington Reservoir County Park and is owned and managed by Valley Water. Lexington Reservoir covers a surface area of 412 acres and has a capacity to hold 19,044 acre-feet of water, making it Valley Water's second-largest reservoir (Valley Water 2021s).

### Limekiln Canyon/Creek

Limekiln Creek is an intermittent stream in a rocky, V-shaped canyon, Limekiln Canyon, which flows east to west into the Lexington Reservoir. Limekiln Creek has a rocky streambed with large cobbles, which opens into a 1.3-acre marshy freshwater wetland immediately before entering the reservoir and is connected to the reservoir by a large, cemented culvert running under Alma Bridge Road. Limekiln Creek is fed by multiple ephemeral drainages on the steep hillslopes adjacent to the canyon. The creek is bounded by freshwater forested/shrub wetland until it reaches the wetland and cemented culvert.

### Soda Springs Creek

Soda Springs Creek is an intermittent stream in a rocky, V-shaped canyon that flows east to west into the Lexington Reservoir. Soda Springs Creek has a rocky streambed with large cobbles and boulders, and is connected to the reservoir by a large, cemented culvert running under Alma Bridge Road. Soda Springs Creek is fed by multiple intermittent and ephemeral drainages on the steep hillslopes adjacent to the canyon. The creek is bounded by freshwater forested/shrub wetland until it reaches Alma Bridge Road.

### Hendry's Creek

Hendry's Creek is an intermittent stream in a rocky, V-shaped canyon that flows east to west into the Lexington Reservoir. Hendry's Creek has a rocky streambed with large cobbles and is channelized by a medium-sized cemented culvert running under Alma Bridge Road. The creek opens into a shrub-dominated freshwater wetland immediately before joining Los Gatos Creek and then entering Lexington Reservoir. Multiple ephemeral drainages feed Hendry's Creek on the steep hillslopes adjacent to the canyon. The creek is bounded by freshwater forested/shrub wetland until it reaches the wetland confluence with Los Gatos Creek.

### Culverts/Drainage

In addition to the waterbodies described above, several smaller culverts and drainages built and maintained by Santa Clara County have been observed throughout the Project area along Alma Bridge Road to convey water parallel to, or underneath the roadway from upslope (east) westward toward Lexington Reservoir. These range from 12 inches to 60 inches in diameter, with most between 12 inches and 30 inches. Although a formal inventory of the drainage facilities has not been performed to date, an inventory of these facilities will be performed at a later date as part of the Project during Phase I (Task 2).

Created By: sally@anr.net Path: \\na.aecomnet.com\GIS\Projects\GIS\Projects\61887532\_AlmaBridgeRoad\02\_Map\02\_Report\_Map\Technical Review\Figure 5\_Existing Facilities.mxd

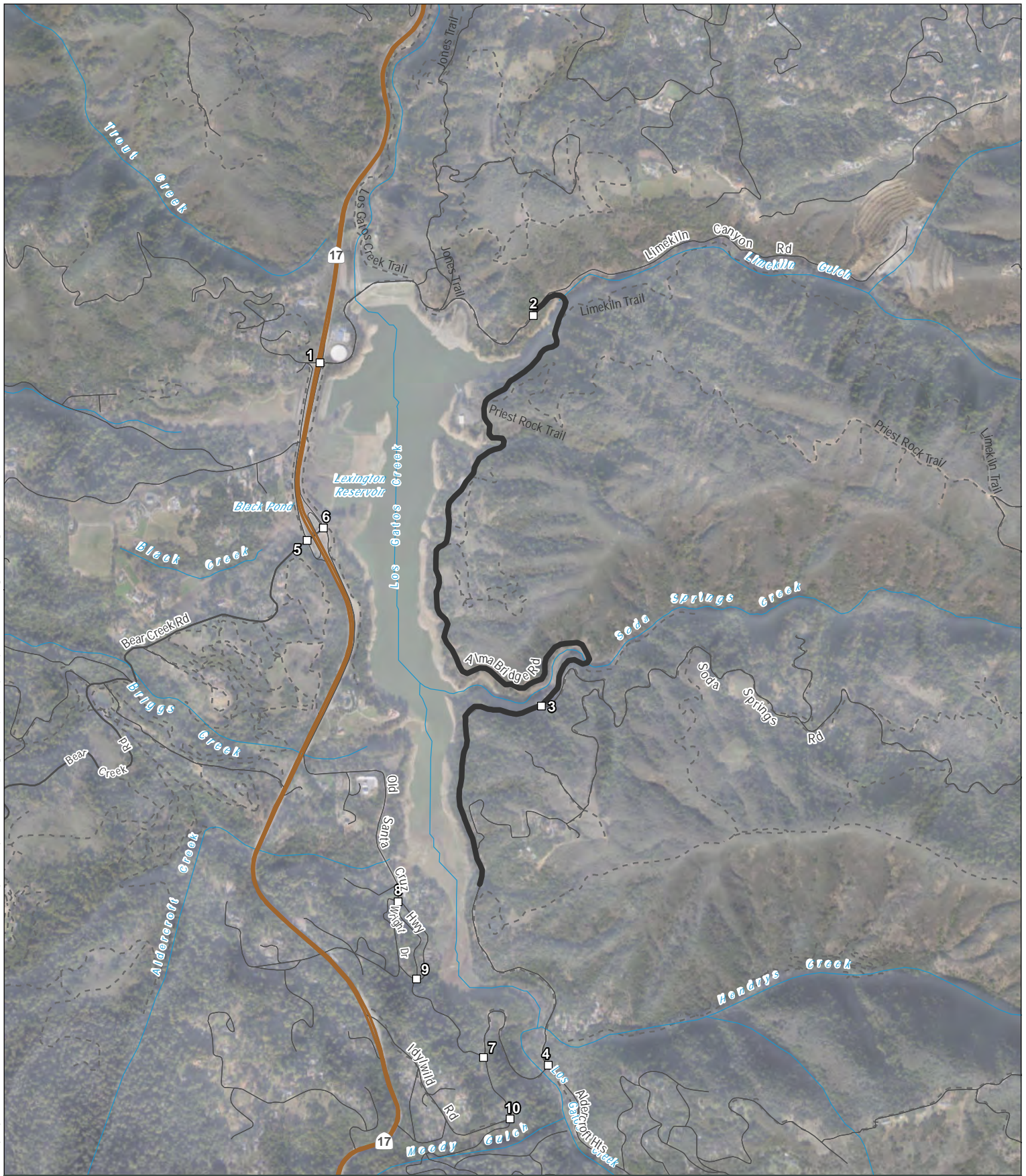

**Figure 5: Existing Facilities and Road Features**

▬ Study Area (along Alma Bridge Rd)  
— River

- Major Intersection  
 1. Highway 17 (northbound)/Alma Bridge Rd  
 2. Alma Bridge Rd/Limekiln Canyon Rd  
 3. Alma Bridge Rd/Soda Springs Rd  
 4. Alma Bridge Rd/Aldercroft Heights Rd  
 5. Hwy 17 (southbound)/Bear Creek Rd Overcrossing

6. Bear Creek Rd/Old Santa Cruz Hwy  
 7. Old Santa Cruz Hwy/Aldercroft Heights Rd  
 8. Wright Dr (north)/Old Santa Cruz Hwy  
 9. Wright Dr (south)/Old Santa Cruz Hwy  
 10. Old Santa Cruz Hwy/Idylwild Dr

Midpeninsula Regional  
 Open Space District  
 (Midpen)  
 8/19/2022



Miles



**AECOM**

While the District strives to use the best available digital data, these data do not represent a legal survey and are merely a graphic illustration of geographic features.

## Special-Status Species

Based on a review of the California Department of Fish and Wildlife's (CDFW) California Natural Diversity Database (CNDDDB) (CDFW 2022), the U.S. Fish and Wildlife Service's (USFWS) IPaC Species List (USFWS 2022a), the Midpeninsula Regional Open Space District's Sensitive Species List (MROSD 2017), and Project stakeholder familiarity with the region, the following special-status species are known to occur, or have the potential to occur in the vicinity of the Project (Figures 6a and 6b, Table 2). Five of these species (Santa Cruz black salamander, California giant salamander, foothill yellow-legged, California red-legged frog, and southwestern pond turtle) are described above as secondary herpetofauna. This Project will be designed to avoid and/or minimize impacts to these species and may also provide some benefits to their habitat permeability.

Early in the planning stages, any number of bird species (waterbirds, raptors, and other passerine and non-passerine species) have some potential to nest, forage, or overwinter on site. These can be addressed at greater length during future permitting efforts. Collectively, the species in Table 2 may warrant further consideration during future permitting efforts. However, many of these species were identified during the preparation of CDFW and USFWS species lists but are unlikely to occur, or could be ruled out based on final Project design, formal habitat assessments, species' known ranges, the availability of suitable habitat, and the results of reconnaissance or protocol-level surveys.

Midpen is currently conducting rare plant surveys in the vicinity of the Project; the results of those surveys will be incorporated into later CEQA and permitting phases once they have been completed.

Created by: sally@midpen.org Path: \\na.aecomnet.com\GIS\Projects\GIS\Projects\60887532\_AlmaBridgeRoad\02\_Maps\02\_Report\_Map\Technical\Review\Figure 6a\_CNDDb Plants 5 mi.mxd

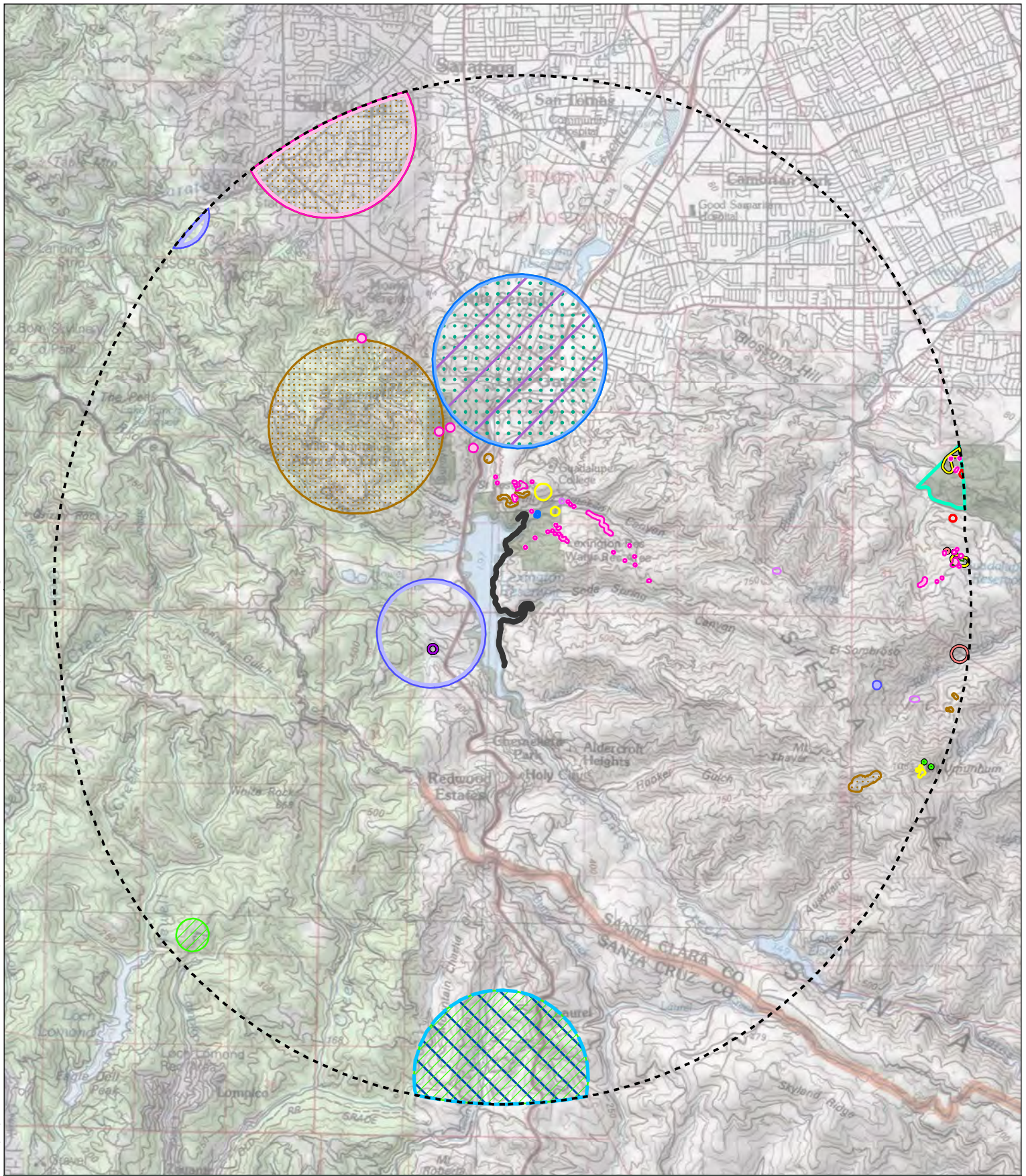

**Figure 6a: CNDDB Records Plants**

- |                               |                            |                            |                        |
|-------------------------------|----------------------------|----------------------------|------------------------|
| Alma Bridge Rd                | Mt. Hamilton thistle       | arcuate bush-mallow        | rock sanicle           |
| 5-mile Buffer of Project Area | San Francisco collinsia    | bent-flowered fiddleneck   | smooth lessingia       |
| <b>CNDDB Records</b>          | Sanford's arrowhead        | fragrant fritillary        | western leatherwood    |
| Ben Lomond spineflower        | Santa Clara Valley dudleya | hairless popcornflower     | woodland woollythreads |
| Bonny Doon manzanita          | Santa Clara red ribbons    | most beautiful jewelflower |                        |
| Loma Prieta hoita             | Santa Cruz wallflower      | robust spineflower         |                        |

Midpeninsula Regional  
Open Space District  
(Midpen)  
8/19/2022



While the District strives to use the best available digital data, these data do not represent a legal survey and are merely a graphic illustration of geographic features.

Created By: sally.ah.ah.ah@midpen.org Path: \\na.aecomnet.com\GIS\Projects\GIS\Projects\61887532\_AlmaBridgeRoad\02\_Map\02\_Report\_Map\Technical Review\Figure 6b\_CNDDDB Animals 5 mi.mxd

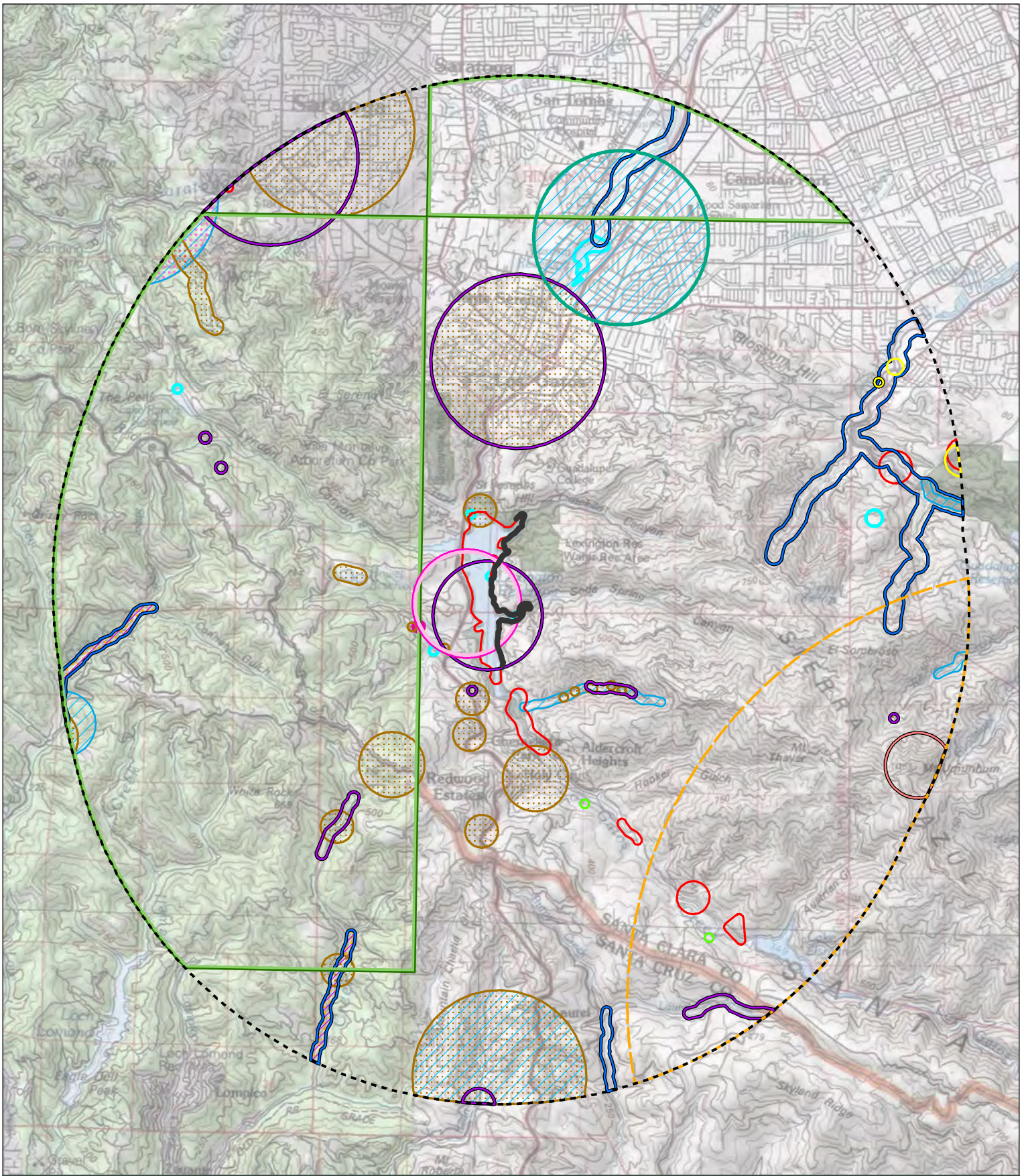

**Figure 6b: CNDDDB Records Animals**

- Alma Bridge Rd
- 5-mile Buffer of Project Area
- CNDDDB Records**
- American peregrine falcon
- California giant salamander
- California red-legged frog
- California tiger salamander - central California DPS
- Crotch bumble bee
- North Central Coast Drainage Sacramento Sucker/Roach River
- Santa Cruz black salamander
- Santa Cruz kangaroo rat
- Townsend's big-eared bat
- Zayante band-winged grasshopper
- coho salmon - central California coast ESU

- foothill yellow-legged frog
- hoary bat
- osprey
- pallid bat
- purple martin
- steelhead - central California coast DPS
- western pond turtle

Midpeninsula Regional  
Open Space District  
(Midpen)  
8/19/2022



While the District strives to use the best available digital data, these data do not represent a legal survey and are merely a graphic illustration of geographic features.

**Table 2.** Special Status Species with Potential to Occur in the Project Area

Common Name	Scientific Name	Listing Status <sup>1</sup>
<b>Plants</b>		
Ben Lomond spineflower	<i>Chorizanthe pungens</i> var. <i>hartwegiana</i>	FE, CRPR 1B.1
Ben Lomond wallflower	<i>Erysimum teretifolium</i>	FE, CRPR 1B.1
Bigberry manzanita	<i>Arctostaphylos glauca</i>	Locally Rare <sup>6</sup>
Bonny Doon manzanita	<i>Arctostaphylos silvicola</i>	CRPR 1B.2
Most beautiful jewelflower	<i>Streptanthus albidus</i> ssp. <i>peramoenus</i>	1B.2
Metcalf Canyon jewelflower	<i>Streptanthus albidus</i> ssp. <i>Albidus</i>	FE, CRPR 1B.1
robust jewelflower	<i>Chorizanthe robusta</i> var. <i>robusta</i>	FE, CH, CRPR 1B.1
Santa Clara Valley dudleya	<i>Dudleya setchellii</i>	FE, CRPR 1B.1
arcuate bush-mallow	<i>Malacothamnus arcuatus</i>	CRPR 1B.2
bent-flowered fiddleneck	<i>Amsinckia lunaris</i>	CRPR 1B.2
Congdon's tarplant	<i>Centromadia parryi</i> ssp. <i>Congdonii</i>	CRPR 1B.1
fragrant fritillary	<i>Fritillaria liliacea</i>	CRPR 1B.2
hairless popcorn flower	<i>Plagiobothrys glaber</i>	CRPR 1A
Loma Prieta hoita	<i>Hoita strobilina</i>	CRPR 1B.1
Mt. Hamilton thistle	<i>Cirsium fontinales</i> var. <i>campylon</i>	CRPR 1B.2
Gray pine	<i>Pinus sabiniana</i>	Locally Rare <sup>6</sup>
rock sanicle	<i>Sanicula saxatilis</i>	CRPR 1B.2
San Francisco collinsia	<i>Collinsia multicolor</i>	CRPR 1B.2
Sanford's arrowhead	<i>Sagittaria sanfordii</i>	CRPR 1B.2
Santa Clara red ribbons	<i>Clarkia concinna</i> ssp. <i>automixa</i>	CRPR 4.3
Scrub oak	<i>Quercus berberidifolia</i>	Locally Rare <sup>6</sup>
smooth lessingia	<i>Lessingia micradenia</i> var. <i>glabrata</i>	CRPR 1B.2
western leatherwood	<i>Dirca occidentalis</i>	CRPR 1B.2
woodland woollythreads	<i>Monolopia gracilens</i>	CRPR 1B.2
<b>Invertebrates</b>		
Crotch bumble bee	<i>Bombus crotchii</i>	SC
Zayante band-winged grasshopper	<i>Trimerotropis infantilis</i>	FE, CH
Monarch butterfly	<i>Danaus plexippus</i>	FC,
<b>Amphibians</b>		
California tiger salamander ( <i>central California DPS</i> )	<i>Ambystoma californiense</i>	FT, CH, ST, CSC
California red-legged frog	<i>Rana draytonii</i>	FT, CH, CSC
foothill yellow-legged frog <sup>7</sup>	<i>Rana boylei</i>	SE
California giant salamander	<i>Dicamptodon ensatus</i>	CSC
Santa Cruz black salamander	<i>Aneides flavipunctatus niger</i>	CSC
<b>Reptiles</b>		
southwestern pond turtle	<i>Actinemys pallida</i>	CSC, FC
coast horned lizard	<i>Phrynosoma blainvillii</i>	CSC

**Table 2 Continued.** Special Status Species with Potential to Occur in the Project Area

Common Name	Scientific Name	Listing Status <sup>1</sup>
<b>Birds<sup>8</sup></b>		
waterbirds ( <i>water associated</i> ) <sup>2</sup>	--	--
raptors ( <i>owls and raptors</i> ) <sup>3</sup>	--	--
land birds ( <i>other passerines and non-passerines</i> ) <sup>4</sup>	--	--
<b>Mammals<sup>8</sup></b>		
special-status bats <sup>5</sup>	--	CSC or WBWG
ring-tailed cat	<i>Bassariscus astutus</i>	FP
Santa Cruz kangaroo rat	<i>Dipodomys venustus</i>	Locally Rare <sup>6</sup>
San Francisco dusky-footed woodrat	<i>Neotoma fuscipes annectens</i>	CSC
mountain lion	<i>Puma concolor</i>	SC
American badger	<i>Taxidea taxus</i>	CSC

<sup>1</sup> **FE** = Federally Endangered, **FT** = Federally Threatened, **FC** = Federal Candidate, **CH** = Critical Habitat (designated), **SE** = State Endangered, **ST** = State Threatened, **SC** = State Candidate, **FP** = Fully Protected (CDFW), **CSC** = California Species of Special Concern, **WBWG** = Western Bat Working Group, **California Rare Plant Rank (CRPR) 1A** = Presumed extirpated, **CRPR 1B.1** = Rare, threatened, or endangered in California or elsewhere/Seriously threatened, **CRPR 1B.2** = Rare, threatened, or endangered in California or elsewhere;/Moderately threatened in California, **CRPR 4.3** = Watch list plant of limited distribution/Not very threatened in California

<sup>2</sup> **Water birds** = least bittern, California gull, long billed curlew, American white pelican, California brown pelican, double crested cormorant, Virginia rail, Clark’s grebe, western grebe,

<sup>3</sup> **Raptors** = sharp-shinned hawk, golden eagle, short-eared owl, long-eared owl, burrowing owl, ferruginous hawk, Swainson’s hawk, northern harrier, white-tailed kite, merlin, American peregrine falcon, bald eagle, osprey, Cooper’s hawk

<sup>4</sup> **Land Birds** = tri-colored blackbird, grasshopper sparrow, Vaux’s swift, olive-sided flycatcher, black swift, willow flycatcher, California horned lark, yellow-breasted chat, loggerhead shrike, Nuttall’s woodpecker, purple martin, yellow warbler, rufous hummingbird, Allen’s hummingbird, Lawrence’s goldfinch, least Bell’s vireo, Bullock’s oriole, California thrasher, oak titmouse, wrenit, yellow-billed magpie

<sup>5</sup> **Special-Status Bats** = pallid bat, Townsend’s big-eared bat, western red bat, hoary bat, long-eared myotis, fringed myotis, long-legged myotis

<sup>6</sup> **Locally Rare** = MROSD special designation

<sup>7</sup> **Locally Extirpated**

<sup>8</sup> **Note:** The potential for special-status birds and bats will be determined during subsequent permitting phases, at which time individual species will be addressed based on the presence of suitable habitat; at a later date, focused or protocol-level surveys will identify nest and roost sites, and will determine the need for standard avoidance and minimization measures.

**Date Sources:** CDFW 2022, USFWS 2022a, MROSD 2022



## Roadways

The primary roadway in the Project area is Alma Bridge Road, a 24-ft wide, two-lane (one lane in each direction) County road that extends 4.64 miles (between Aldercroft Heights Road and Highway 17) that passes through the Project area as it circumnavigates the northern and eastern shores of Lexington Reservoir (Figure 5). It is described in relation to its general position in the landscape (below), as well as in more detail regarding the roadway's technical specifications under County As-Builts.

### Alma Bridge Road

Based on a review of historical topographic maps, Alma Bridge Road was constructed immediately after the construction of the Lexington Reservoir ca. 1952. By 1953, most of the roadway along the eastern shore of the reservoir between Limekiln Creek and Hendry's Creek had been paved; the remaining roadway across the dam connecting Highway 17 and Alma Bridge Road at Limekiln Creek was constructed shortly thereafter. Road construction appears to have been a combination of cut-and-fill and benched roadway.

Each lane on Alma Bridge Road ranges from 10 to 11 ft wide, with double yellow striping separating the lanes. Just north of Soda Spring Canyon, a small segment of roadway (225 ft long) narrows to a single lane that is shared by both directions of traffic, with stop signs on both ends and a concrete barrier along the west side of the road. This single-lane segment appears to be a temporary fix to the west edge of the road collapsing.

The shoulders are mostly narrow extensions of the asphalt pavement road surface that vary from 0 feet to several feet wide. Short sections of dirt and gravel along the roadway also serve as shoulders and vehicle pullouts. Alma Bridge Road is maintained by Santa Clara County Roads and Airports Department. The asphalt pavement was repaved twice in 2021 and is in very good condition. Alma Bridge Road is designated as a primary evacuation route during emergencies (such as a wildfire) in the surrounding area.

The speed limit along Alma Bridge Road is 25 mph. There are no speed bumps, rumble strips, or other physical speed control features, but there are yellow warning signs with lower speed limit recommendations for sharp turns and winding sections of road. There are also recently installed newt crossing warning signs placed every mile.

Alma Bridge Road provides access to three primary County roads east of the Reservoir. Limekiln Canyon Road is a private drive that provides access to the Lexington Quarry. Soda Springs Road provides access to scattered rural residences east of the Project Area and is designated as a secondary evacuation route during emergencies (such as a wildfire) in the surrounding area. Aldercroft Heights Road provides access to the Lupin Lodge and the rural residential neighborhood Lexington Hills southeast of the Project and is also designated as a primary evacuation route during emergencies (such as a wildfire) in the surrounding area.

For southbound Highway 17 traffic, Alma Bridge Road can only be approached from the north by taking the Bear Creek Road/Gillian Cichowski Memorial Overcrossing (right on Bear Creek Road) and merging back onto Highway 17 traveling north via Old Santa Cruz Highway (left on Old Santa Cruz Highway) and taking the Alma Bridge Road exit (right). Following a more circuitous route, southbound Highway 17 traffic can also approach Alma Bridge Road from the south by taking the Bear Creek Road/Gillian Cichowski Memorial Overcrossing (right on Bear Creek Road), traveling south via Old Santa Cruz Highway (right on Old Santa Cruz Highway) and Aldercroft Heights Road (left on Aldercroft Heights Road) until the Alma Bridge Road/Aldercroft Heights Road junction.

For northbound Highway 17 traffic, Alma Bridge Road can be approached from the north by taking the Alma Bridge Road exit (right). Northbound Highway 17 traffic can also approach Alma Bridge Road from the south by taking the Bear Creek Road (right on Bear Creek Road), traveling south via Old Santa Cruz Highway (merge onto Old Santa Cruz Highway) and Aldercroft Heights Road (left on Aldercroft Heights Road) until the Alma Bridge Road/Aldercroft Heights Road junction. For northbound Highway 17 traffic, several other roads provide connectivity with Alma Bridge Road indirectly through Old Santa Cruz Highway, including Hebard Road/Wright Drive, Idylwild Road, Ranier Lane/Idylwild Road, and Madrone Drive (among others).

Considered together, there are a total of 10 key intersections that connect this network of roads to Alma Bridge Road (Figure 5):

- Highway 17 (northbound)/Alma Bridge Road (#1)
- Alma Bridge Road/Limekiln Canyon Road (#2)
- Alma Bridge Road/Soda Springs Road (#3)
- Alma Bridge Road/Aldercroft Heights Road (#4)
- Highway 17 (southbound)/Bear Creek Road-Gillian Cichowski Memorial Overcrossing (#5)
- Bear Creek Road/Old Santa Cruz Highway (#6)
- Old Santa Cruz Highway/Aldercroft Heights Road (#7)
- Wright Drive (north)/Old Santa Cruz Highway (#8)
- Wright Drive (south)/Old Santa Cruz Highway (#9)
- Old Santa Cruz Highway/Idylwild Drive (#10)

At each of these intersections, motorists must make a decision that may lead them to travel along portions of Alma Bridge Road and through the Project area.

### **Traffic Data**

Two recent sets of traffic data are available for the Project study area.

The County of Santa Clara collected vehicle counts for both directions of Alma Bridge Road for an 8-day period from January 25 to February 2, 2022. The counts were taken at approximately 0.25 mile north of Soda Spring Creek and just north of the one-way segment described above. Average daily traffic (ADT) volumes generally ranged from 175 to 222 vehicles, although one day during the count period had an ADT of 621, likely due to vehicles diverting to Alma Bridge Road due to a traffic incident on Highway 17. The highest vehicle volumes were between 7 am and 9 am, followed by 2 pm to 4 pm. The lowest volumes were between 7 pm and 6 am. Apart from the day with an ADT of 621 (a Monday), ADTs were generally similar on weekdays and weekends, with the highest ADTs on Friday, Saturday, and Tuesday (Santa Clara County Roads and Airports 2022).

As part of the 2021 H.T. Harvey study, a traffic counter was placed across Alma Bridge Road near the Santa Clara University and Los Gatos Rowing Club facility and Priest Rock Trailhead. Traffic counts were collected from November 8, 2020, to March 31, 2021. The ADT recorded during this period was 577. The total vehicle count for the 148-day period was 83,757. The maximum 24-hour vehicle count was 1,008 (from 9:00 am on Monday, January 18 to 9:00 am on Tuesday, January 19, 2021), and the minimum 24-hour vehicle count was 233 (from 9:00 am on Tuesday, December 17 to 9:00 am on Wednesday, December 18, 2020).

Similar to the 2022 County traffic data, daily traffic volumes decreased substantially in the evening. For example, the average 10-hour vehicle count from 8:00 pm to 5:00 am was 27, with a maximum count of 231 during the same time period between Monday, January 18 and Tuesday, January 19, 2021, and a minimum count of six vehicles during the same time period between Friday, November 10 and Saturday, November 11, 2020, Friday, December 25, and Saturday December 26, 2020, and between Thursday, December 31, 2020 and Friday, January 1, 2021. There also appeared to be a reduction of traffic from mid-December to the end of that month, but a general trend of increasing traffic over the survey period.

As the 2022 traffic data was for a substantially shorter period (8 days) than the 2020-2021 data (148 days), it is not possible to make definitive conclusions about traffic volume or pattern trends in the study area. A comparison of volumes between the 2022 data and the 2020-2021 data suggests that Alma Bridge Road in the northern part of the study area is more heavily traveled than in the southern part of the study area. The northern half of Alma Bridge Road per Parsons (2021) includes roughly the Douglas B. Miller Memorial Point recreation area northward. If so, then higher volumes in the northern part of the study area likely associated with traffic to and from recreational facilities including existing County Parks parking lots, roadside pullouts, trailheads, the rowing club, and Lexington Quarry. Traffic to these destinations is likely to access Alma Bridge Road from the turnoff along northbound Highway 17, near the northern end of Lexington Reservoir. This is the shortest route to these destinations from Highway 17, even for southbound travelers. (Since there is no ramp

connecting southbound Highway 17 with the Alma Bridge Road turnoff, travelers must access the turnoff by exiting the highway at Bear Creek Road, crossing Highway 17, taking the northbound ramp, and heading approximately 0.5 mile north.) Additional count data could confirm whether Alma Bridge Road traffic volumes are typically higher in the northern part of the study area than in the southern part. The locations of previously placed meters may have missed key demographics of road users, including drivers to the quarry, three trailheads, and various fishing stops along the shorelines of Lexington Reservoir that may have turned around before intersecting with and triggering a traffic meter.

Due to the current traffic/usage level of the road described above, including Alma Bridge Road's emergency access designation, road closures and/or permit only use of the road is not considered feasible. Furthermore, these options would divert road traffic onto other local roadways, would preclude and limit recreational use of the area, and would be challenging to effectively implement and enforce.

### **County As-Builts**

The County of Santa Clara, San Jose Water, and Valley Water provided as-built plans for improvements along Alma Bridge Road in the Project area. The Alma Bridge Road bridge over the reservoir spillway was seismically retrofit in 1985 and modified to include safety railings and barriers in 1986. A seismic retrofit of the roadway bridge just west of the dam spillway was completed in 1999. In 1996, the culvert at Soda Springs Creek under Alma Bridge Road was replaced with a 16.25-ft by 19.83-ft, 150-ft long vertical elliptical pipe, and the culvert at Limekiln Creek under Alma Bridge Road was replaced with a 21.5-ft by 23.8-ft, 150-ft long vertical elliptical pipe. The culvert types at these locations prior to their replacements is unknown. In the culvert replacement areas, Alma Bridge Road consists of 4 inches of asphalt concrete on top of 6 inches of Class III aggregate base (Figure 7a and 7b).

### **Data Limitations**

With the as-builts we currently have access to, we are rather limited in our ability to describe the existing road conditions in greater detail. Most of the current as-builts focus on the northwest portion of Alma Bridge Road closest to Highway 17 which is outside of the Project area. If more as-builts can be located and as more geographic information is collected, it will be especially important to focus on topographic data, utility locations, and existing culvert designs and locations. This will greatly help determine the location, design, and estimated cost of potential corrective actions. County Roads has provided all as-builts they have access to of Alma Bridge Road.

## **Land Ownership**

Santa Clara County Roads and Airports Department owns and maintains Alma Bridge Road. Other landowners in the vicinity of Alma Bridge Road consist of open space managers (Midpen, Santa Clara County Parks and Recreation Department [County Parks]), watershed and water operation managers (Valley Water, San Jose Water Company), commercial entities (Lexington Quarry and Lupin Lodge), and private property owners of intermittent rural and rural residential homes (Lexington Hills, Chemeketa Park, and informally, Soda Springs Road) (Figure 8).

### **Midpeninsula Regional Open Space District (Midpen)**

The Midpeninsula Regional Open Space District oversees 62,000 acres of open space in San Mateo, Santa Clara, and a small portion of Santa Cruz counties. East of Lexington Reservoir (off-site), Midpen's Sierra Azul Open Space Preserve, which is open to the public, also includes the Cathedral Oaks Area watershed lands, which are currently closed to the public.

Future recreation access has been proposed at the former Beatty Property along the east side of Alma Bridge Road. The Beatty Parking Area and Trail Connections Project aims to develop public access and parking for the Cathedral Oaks area of the Sierra Azul Open Space Preserve, including a new trail connection to the Priest Rock Trail. The Project is currently on hold while options to enhance newt connectivity across Alma Bridge Road are developed.

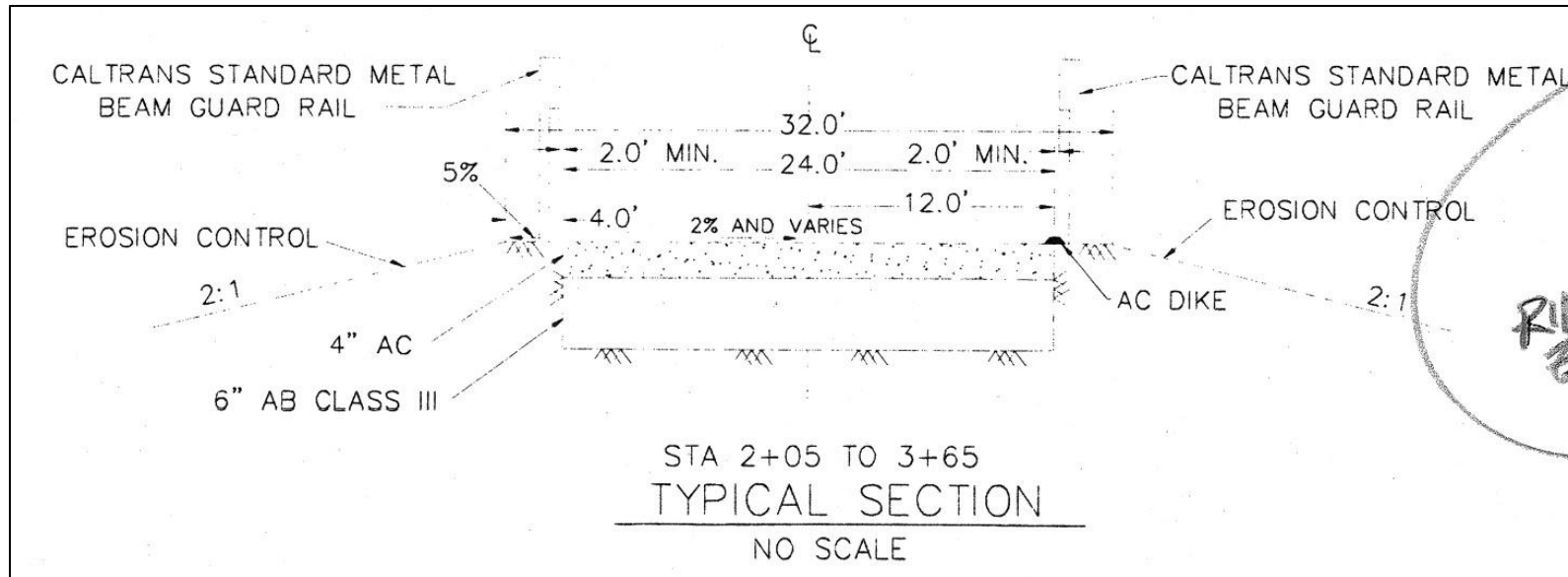

**Figure 7a: Limekiln Creek Culvert Typical Cross Section**

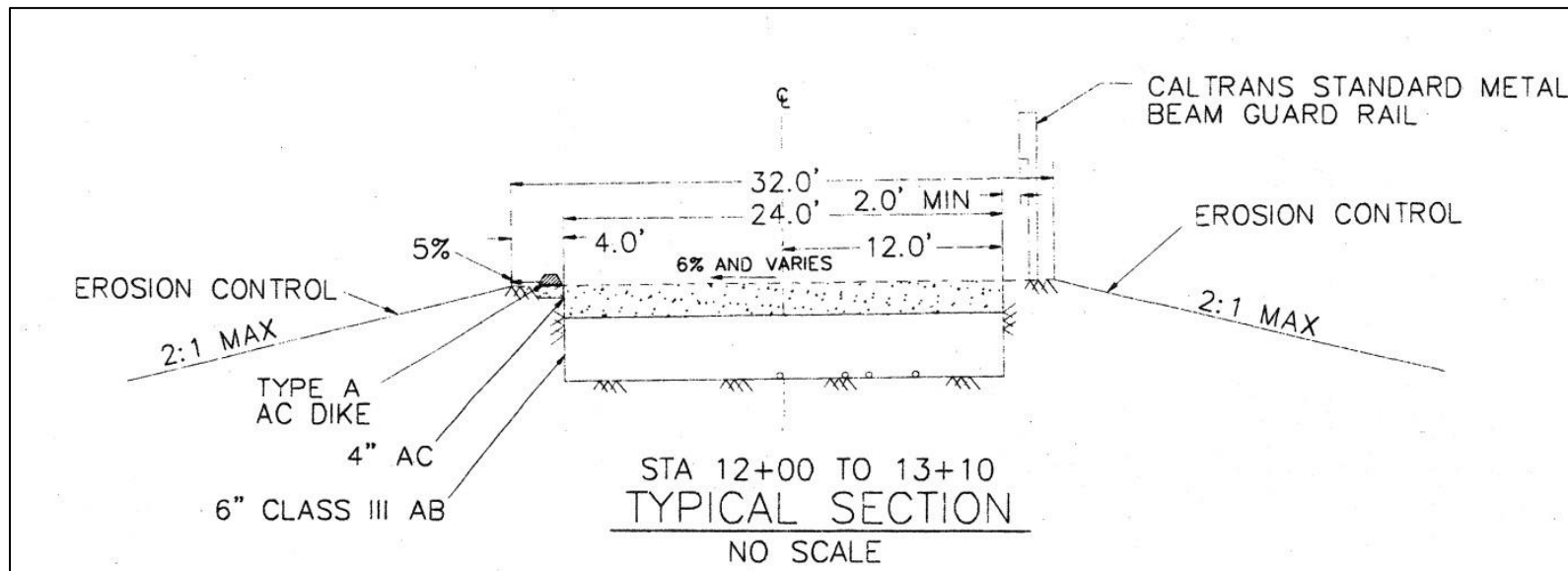

**Figure 7b: Soda Springs Culvert Typical Cross Section**

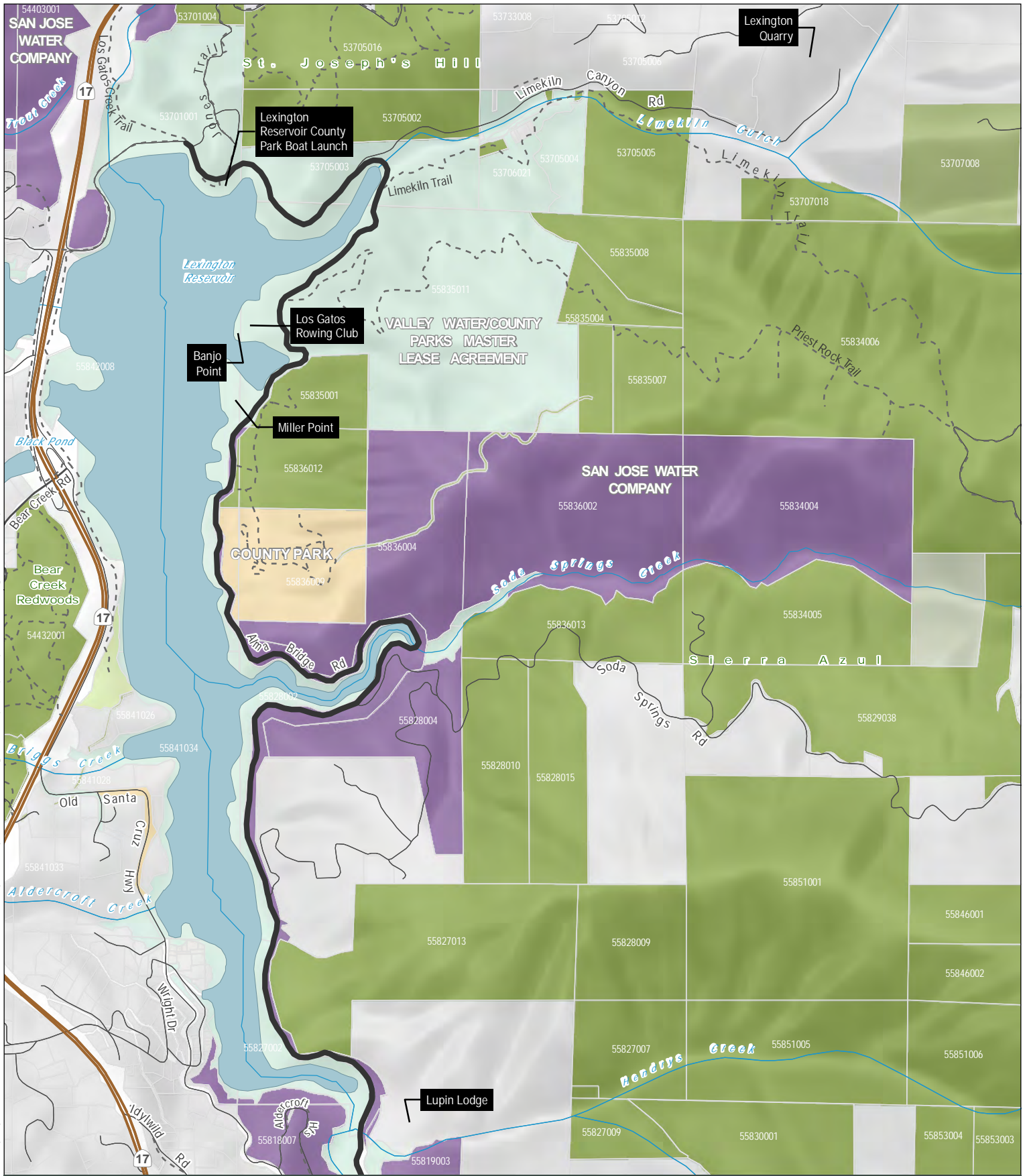

**Figure 8: Land Ownership**

- Study Area (along Alma Bridge Rd)
- Existing Trail
- Midpen Preserve
- Valley Water Property
- County Parks Property
- SJWC Property
- Other Protected Land
- Private

Midpeninsula Regional  
Open Space District  
(Midpen)  
1/6/2023



While the District strives to use the best available digital data, these data do not represent a legal survey and are merely a graphic illustration of geographic features.

**Santa Clara County Parks and Recreation Department (County Parks)**

Alma Bridge Road is the main access to Lexington Reservoir County Park, a 950-acre facility centered around the 338-acre Lexington Reservoir. This public park offers day use recreation along the reservoir shoreline, boating in hand-launched nonmotorized vessels, and access to adjacent trails and preserves, including the Los Gatos Creek Trail and trails in the St. Joseph's Hill and Sierra Azul Open Space Preserves. Visitor facilities are described further under "Recreational Amenities," below.

**Valley Water**

Valley Water is a public water utility agency that serves Santa Clara County. Valley Water owns and operates Lexington Reservoir water resources (described above). Valley Water lands surrounding the Reservoir are under a Master Partnership Agreement with County Parks, which provides water and land based recreational opportunities, such as public and private boating, fishing, hiking, cycling, and wildlife observation.

**San Jose Water Company**

The San Jose Water Company is a private water utility that serves the greater San Jose metropolitan area. A portion of the San Jose Water Company's watershed land straddles Alma Bridge Road and adjoins Lexington Reservoir at Soda Springs Creek.

**Santa Clara University and Los Gatos Rowing Club**

The Los Gatos Rowing club, founded in 1979, is located on the eastern shore of Lexington Reservoir, and can be accessed from Alma Bridge Road. The club facilities consist of a boathouse, dock, and parking lot. The club shares its facilities with the Santa Clara University rowing team. Santa Clara University and Los Gatos Rowing Club operate these facilities under a lease from County Parks.

**Lexington Quarry**

The Lexington Quarry, established in 1989, is owned and operated by Vulcan Materials Company and is located off Limekiln Canyon Road and consists of an aggregate stone (crushed/broken) quarry located along a tributary of Limekiln Canyon.

**Lupin Lodge**

The Lupin Lodge Naturist Resort, established in 1935, is located just south of the Alma Bridge Road/Aldercroft Heights Road junction, and consists of overnight lodging (tent, RV, yurts), restaurant, hiking trails, and recreational facilities (i.e. pool, volleyball/tennis courts).

**Rural and Rural Residential Properties**

There are three rural residential neighborhoods whose access depends wholly or in part on Alma Bridge Road. The Soda Springs neighborhood east of Soda Springs Creek can only be accessed by Soda Springs Road. The rural residential Lexington Hills neighborhood southeast of Hendry's Creek can only be accessed by Aldercroft Heights Road. And the residential Chemeketa Park neighborhood east of Highway 17 and southwest of Hendry's Creek can be accessed from Highway 17 or Alma Bridge Road by either Old Santa Cruz Highway, Aldercroft Heights Road, or Idylwild Drive.

**Land Use**

The Project area is in unincorporated Santa Clara County. The entire area surrounding Lexington Reservoir, including Alma Bridge Road, is designated as a Resource Conservation Area. This designation provides for low-density residential and non-residential uses that are consistent with retaining the rural characteristics of the land and preserving natural resources and functions, including streams and other drainages (County of Santa Clara 1994). Land uses in the Project area are mapped as Regional Parks/Existing, Other Public Open Lands, and Hillsides (County of Santa Clara Planning Office 2016).

**Recreational Amenities**

Alma Bridge Road is the main access point to Lexington Reservoir County Park, which has recreational amenities throughout the Project area. Attractions in the vicinity of the Project include day use and parking facilities, trails, and boat launches.

**Parking**

There are multiple designated parking areas within the Project area and along Alma Bridge Road. The largest is the main County Park parking lot (37.20023, -121.98669) that is located on the northern end of Lexington Reservoir, just east of the Leniham Dam spillway. This is a paid parking area and includes designated spaces for trailers. There are additional parking lots at Banjo Point and Miller Point, and several undesignated road shoulders and pull-outs along Alma Bridge Road on the eastern side of the reservoir provide additional parking for anglers, hikers, and other recreationists.

**Trails**

The main County Park parking lot on Alma Bridge Road provides access to the Los Gatos Creek Trail, which extends north to the Town of Los Gatos and continues into San Jose; and the Jones Trail, which connects with other trails in St. Joseph's Hill Open Space Preserve and the Town of Los Gatos Novitiate Park. Farther east and south on Alma Bridge Road are the trailheads for the Limekiln Trail and Priest Rock Trail, which connect with Sierra Azul Open Space Preserve. Priest Rock Trail is part of the Bay Area Ridge Trail and Juan Bautista de Anza National Historic Trail, and can also be accessed from the Limekiln Trail.

**Boat Launches**

Ramps for hand-launching nonmotorized vessels are available at the main parking lot on the northern end of the reservoir and at Banjo Point.

**Other Visitor Amenities**

Picnic tables, fishing areas, portable restrooms, pay phones, and visitor information signboards and maps are available at the main parking lot and Miller Point.

# Best Management Practices

Project team members Thomas Langton, Dr. Anthony Clevenger, and Cheryl Brehme, in association with Caltrans and USGS, recently researched and reviewed the state-of-the-art science in wildlife crossing design to develop comprehensive measures to prevent and reduce road impacts on California wildlife, including herpetofauna. These measures consist of Best Management Practices and technical guidance (hereafter, BMPs) formalized in the recent *Measures to Reduce Road Impacts on Amphibians and Reptiles in California* (Langton and Clevenger 2021) informed by the supporting paper, *Research to Inform Caltrans Best Management Practices for Reptile and Amphibian Road Crossings* (Brehme and Fisher 2021).

The BMPs consist of measures that could be used to minimize the effects of roadways on herpetofauna, and include technical guidance on the planning, design, and evaluation of wildlife passage, barriers, and other associated measures on new or existing highways to facilitate the safe movement of herpetofauna across roads (Langton and Clevenger 2021).

At the onset of a project (e.g. new construction, road widening, lane expansions, road improvement, installation of solid barriers in medians and shoulders, and culvert and bridge retrofits), project- and-system level planning should consider a hierarchy that consists of (1) avoidance (avoiding sensitive habitat), (2) corrective actions (incorporating actions to minimize impacts through barrier and passage system development), and (3) compensation (habitat and connectivity restoration). The BMPs identified in Langton and Clevenger (2021) are reviewed below with an emphasis on using barrier and passage system development to minimize impacts during the proposed Project's current system-level planning phase.

## Crossing System Performance Assessment

A key step in implementing BMPs is evaluating their effectiveness through a performance assessment. Prior to implementation of the wildlife crossing system, design goals and performance objectives should be identified that include measurable criteria. Examples of typical, and project-specific, measurable design goals include:

- A decrease in animal-vehicle road mortality
- An increase in habitat connectivity/reduction in habitat fragmentation
- An increase in the permeability of the road to newt movement (rate of successful crossings)
- Models that indicate persistence of population
- Increased safe use of existing and new crossing structures by target species
- An increase in number of safe crossing structures (Langton and Clevenger 2021, Meese et al. 2007)
- An increase in traffic control and calming
- Continued use of the roadway by vehicles and other recreational users

Based upon the design goals, the framework for a study design should be developed to ensure the necessary data can be collected to inform subsequent analyses. Upon implementation of the wildlife crossing system, the performance assessment should evaluate the crossing system's design goals and performance objectives, and to make recommendations to incorporate adaptive management measures (Langton and Clevenger 2021).

## Adaptive Management

Based on the results of the performance assessment, adaptive management measures should be incorporated to enhance or improve crossing system design functionality and effectiveness. Adaptive management measures could include structural modifications or recommending changes to BMPs and technical guidance to inform future project design and decision-making (Langton and Clevenger 2021).

## Crossing System Maintenance, Retrofitting, and Enhancement

During the post-construction and maintenance phase, or as a result of the performance assessment, adaptive management measures may be necessary to ensure crossing system functionality and effectiveness. Such



measures may include removing obstructions (e.g. sediment, trash), vegetation maintenance, repairing passage structure or barrier material gaps and failures, assessing and repairing damage from vehicles or severe weather, repairing erosion, or incorporating modifications and improvements (Meese et al. 2007, Langton and Clevenger 2021).

## Adjacent Functions and Uses

In addition to a project-level analysis, a landscape level analysis of current and expected land uses and ownership surrounding the proposed Project can help identify the current and expected effectiveness of proposed BMPs and justify the associated expenditure (Meese et al. 2007). In particular, recommendations should consider how current and expected land uses might contribute to a measurable change in future traffic conditions along Alma Bridge Road.

# Crossings Design Guidance

During the design phase, connectivity system design should consider passage design type (Type, size/dimensions) and project-specific design criteria and variables tailored to the target species and project constraints. Barrier design is also integral to help direct the movement of herpetofauna and other wildlife either away from, or to a safe passage across the roadway (Langton and Clevenger 2021). An overview of these wildlife passage and barrier types is provided below. Project conceptual designs may include multiple crossings of one or more types. Site-specific opportunities and constraints present different crossing type successes at different locations.

In addition to BMPs, standard traffic control and calming options (Meese et al. 2007) may also assist in moderating vehicle traffic along Alma Bridge Road, which could lessen the impacts that drivers contribute to the road mortality. Both the BMPs and traffic control and calming options qualify as measures to minimize impacts and are discussed in greater detail below.

## Crossing Structure Design Types

Past studies have successfully demonstrated that crossing structures such as road tunnels are an effective system against roads as dispersal barriers. Combinations of road tunnels and fencing, for example, have been shown to restore amphibian movement and site connectivity in wildlife movement corridors for such species as the California tiger salamander (Brehme et al. 2021), great crested newt (*Triturus cristatus*) (Matos 2017, Jarvis et al. 2019), common toad (*Bufo bufo*) (Ottburg and van der Grift 2019), or amphibians in general (Helldin et al. 2019).

Wildlife system connectivity design generally recognizes five primary crossing structure design types, from large (Type 1) to small (Type 5), but also recognizes the needs for innovative designs such as the recent development of the novel Type 6 structure(s).

### Type 1

Type 1 structures consist of either mountain or hill tunnels (Type 1A), viaducts or open span bridges (Type 1B), or wildlife overpasses (at grade, raised, road, or multi-purpose) (Type 1C), and are typically designed to minimize above-ground disturbances or to span optimal wildlife habitat to preserve it (Langton et al. 2017, Langton and Clevenger 2021).

A hypothetical analog of a Type 1 structure at Alma Bridge Road would be to (a) reroute portions of the Alma Bridge Road roadway between Soda Springs Creek and Limekiln Creek belowground via a tunnel (Type 1A), (b) construct a bridge spanning Limekiln Creek extending north from the Priest Rock Trailhead to Alma Bridge Road (east of the Lexington Reservoir boat launch) (Type 1B), or (c) construct a vehicle tunnel at a location along Alma Bridge Road that was originally developed through cut and fill along the hillside, and restore the overlying hillside to a vegetated overpass (Type 1C) to reroute drivers away from road mortality hotspots along the affected portion(s) of the northern extent of Alma Bridge Road.

### Type 2

Type 2 structures consist of small (60-120 ft) open span bridges and are typically built to span smaller sections of natural habitat, usually with a re-cast, cast on site, or multi-span beam structure (Langton et al. 2017, Langton and Clevenger 2021).

A hypothetical analog of a Type 2 structure at Alma Bridge Road would be to construct a bridge spanning the creek crossing at Limekiln Creek or Soda Springs Creek to reroute drivers away from road mortality hotspots along Alma Bridge Road at Limekiln Canyon or Soda Springs Creek.

### Type 3

Type 3 structures consist of small (<60 ft wide) road underpasses, and are typically built to enhance drainage and, secondarily, facilitate wildlife movement (Langton et al. 2017, Langton and Clevenger 2021).

A hypothetical analog of a Type 3 structure at Alma Bridge Road would be to modify the creek crossings at Limekiln Canyon, Soda Springs Creek, or Hendry's Creek to enhance drainage and wildlife movement opportunities at these locations and redirect wildlife movement underneath the roadway to reduce road mortality.

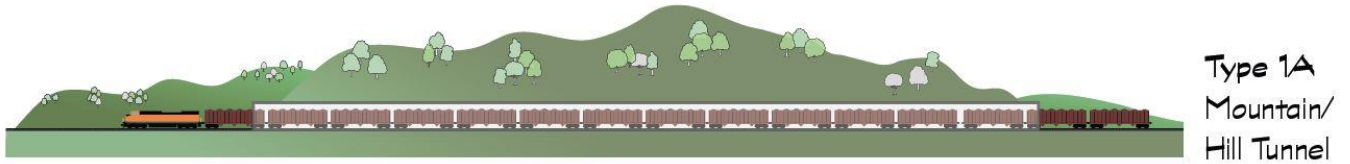

Example of a Type 1 Structure (from Langton and Clevenger 2021)

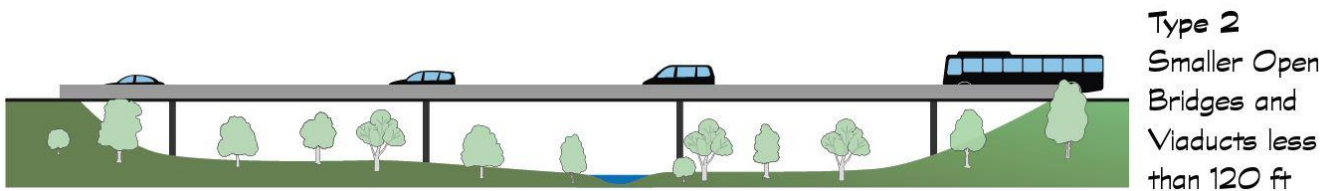

Example of a Type 2 Structure (from Langton and Clevenger 2021)



Example of a Type 3 Structure (from Langton and Clevenger 2021)

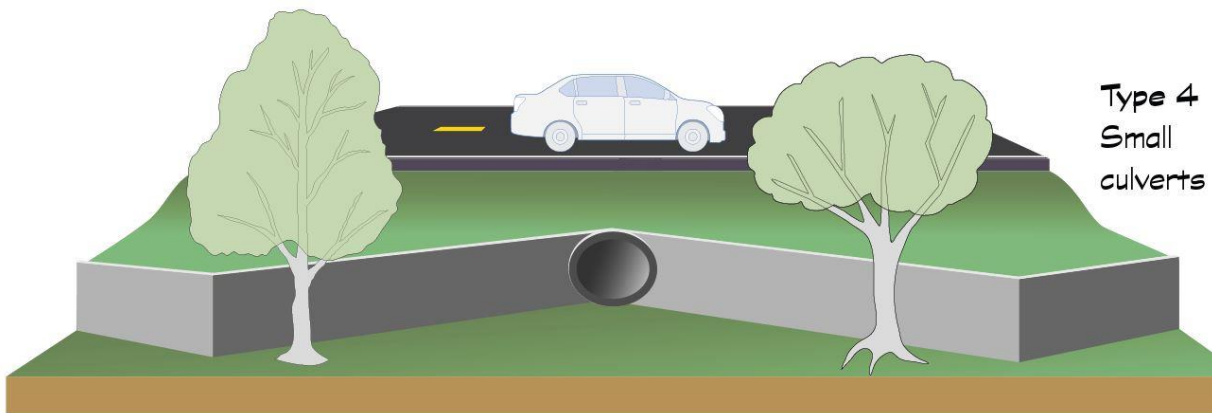

Example of a Type 4 Structure (from Langton and Clevenger 2021)

**Type 4**

Type 4 structures consist of small (< 10 ft wide) culverts, and are typically built to convey seasonal runoff and, secondarily, facilitate wildlife movement (Langton et al. 2017, Langton and Clevenger 2021).

A hypothetical analog of a Type 4 structure at Alma Bridge Road would be to modify or enhance existing drainage culverts at key road mortality hotspots to enhance drainage and wildlife movement opportunities at these locations and redirect wildlife movement underneath the roadway to reduce road mortality. Enhancements may include artificial lighting or modifications to allow natural light to illuminate the corridor.

**Type 5**

Type 5 structures consist of both smaller (< 3 ft wide) water drainage culverts and purpose-built passages designed for wildlife movement (Langton et al. 2017, Langton and Clevenger 2021).

A hypothetical analog of a Type 5 structure at Alma Bridge Road would be to modify or enhance existing drainage culverts or install purpose-built wildlife movement passages at key road mortality hotspots to enhance wildlife movement opportunities at these locations and redirect wildlife movement underneath the roadway to reduce road mortality. Passages would have grated ceilings to allow natural light.

**Type 6**

Type 6 structures consist of microbridges and raised roadways elevated between 8 inches or less, up to several feet above an existing roadway that mimic Type 1B structures on a localized, micro-scale, and are typically designed to span and preserve existing wildlife movement corridors (Langton and Clevenger 22021, Brehme and Fisher 2021, Brehme et al. 2022).

A hypothetical analog of a Type 6 structure would be to elevate portions of Alma Bridge Road at key road mortality hotspots to preserve, and reroute drivers around (=over), existing wildlife movement corridors at these locations to reduce road mortality.



Example of a Type 5 Structure (from Langton and Clevenger 2021)



Example of a Type 6 Structure (from Brehme et al. 2022)

## Crossing Structure Design Criteria and Variables

Key considerations in wildlife passage design include several criteria and variables to minimize wildlife passage “avoidance” responses by species. Wildlife passage design should take into consideration temperature, moisture, light, soil or substrate type, dimensions (see structure types, above, but also *in situ* conditions dictated by road width, etc.), and a species’ behavioral tolerance or resistance to these criteria.

Operationally, wildlife passage design should consider changing conditions associated with climate change, innovative materials to reduce costs, and maintenance needs to keep the crossing structures free of obstructions, with an effort to not generate significantly greater maintenance activities. Design should consider integrating wildlife passage maintenance into existing roadway maintenance considerations, such as routine repaving, sealing, striping, earthen berm and dyke maintenance, among others. Durability and lifecycle costs should be considered for design lifespan and replacement schedule.

Generally, crossing structure design should emphasize structures that emulate ambient environmental conditions and are permeable to rainfall and ambient light (van der Grift et al. 2010, Langton et al. 2017, Langton and Clevenger 2021), and emphasize larger passage size to maximize effectiveness (Hedrick et al. 2019). Crossing structure design will also consider landowners, residents, visitors, and other stakeholders and their interests. The design phase of the Project will consider any effects to these users and seek to produce alternatives that accomplish both wildlife passage and human land use goals.



Example of a Guide Wall (from Langton and Clevenger 2021)

## Barriers

Barriers consist of two types: guide walls, which are typically permanently integrated into the road embankment and often one-way, and fencing, which is typically temporary or semi-permanent. To help direct wildlife movement either away from or to a safe passage across the roadway, key considerations in barrier design should include spacing, frequency, height, barrier-species interactions, placement, and material. Barrier design and installation considerations include installation constraints, drainage, turn-arounds and stop grids, jump-outs, and shelter (Langton and Clevenger 2021). Additionally, Project site conditions *in situ*, such as micro-topography (e.g. slope), drainage, right-of-way, etc., may further restrict the type or placement of guide walls and fencing.

### Spacing

Based on the frequency of crossing structure placement, the placement and spacing of barriers or guide walls should be determined by the target species’ dispersal patterns, migratory behavior, “give-up” or “turn-around” times (see Barrier-Species Interactions, below), and the level of connectivity necessary to sustain a population. Further considerations include barrier angle and directionality (Langton and Clevenger 2021). Brehme et al. (2021) recommend a maximum of 12.5 m between passages (as determined through a study looking at California tiger salamander [*Ambystoma californiense*] movement and response to barrier fencing).

### Height

Installation height above- and below-ground should be based on the target species’ ability to climb, jump, or burrow, as well as the type of barrier material. Other considerations to consider include vegetation growth alongside barriers (and the associated timing/frequency of vegetation maintenance), and the need for barrier overhangs to prevent over-climbing. The recommended minimum barrier height for salamanders and newts is 18 to 25 inches with the need for added overhangs (Langton and Clevenger 2021).

### Barrier-Species Interactions

Barrier types should take into account how a species responds to an obstruction when they encounter a

barrier. Factors to consider include the target species' dependence on visual and olfactory cues, the speed and time of travel spent interacting with an obstruction, and a species' "give-up" or "turn-around" time (i.e. the point at which a species abandons their migratory movement). All of these factors dictate the need for a solid versus an open (e.g., mesh) barrier type, the type, and the length (see Spacing, above) of material (Brehme et al. 2021, Langton and Clevenger 2021).

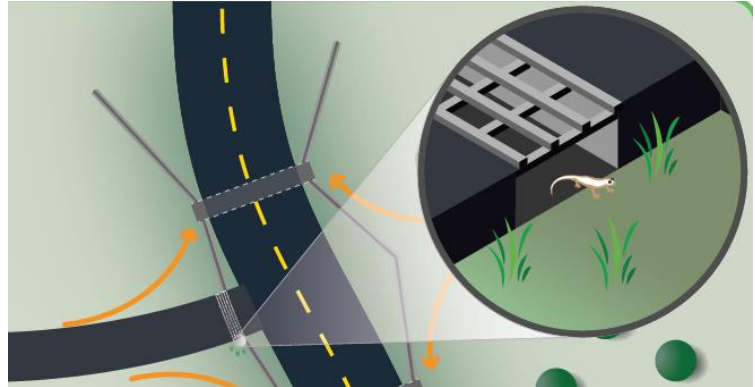

Example of a Stop Grid (from Langton and Clevenger 2021)

**Turn-arounds, Stop Grids, and Jump-outs**

The endpoints of a barrier system are an integral part of barrier design and can significantly influence the overall effectiveness of crossing structures and barrier systems. At the terminal ends of a barrier array, turn-arounds can not only redirect species back toward a crossing structure, but can also deflect movement away from the roadway. Turn-arounds can also consist of integrating the barrier system into natural landscape features, such as the base of a cliff, or graduating the curvature of a barrier sufficiently that it redirects species back into a natural environment (rather than a roadway) and minimize any overshoot (Brehme and Fisher 2021, Langton and Clevenger 2021).

Stop grids consist of grates whose purpose is to "catch" species and redirect their movement by dropping them into a passageway, away from the roadway. Stop grids are often implemented where crossing structure and barrier systems cross private and public roads (Langton and Clevenger 2021).

Jump-outs provide escape opportunities for target and non-target species that find themselves on the wrong side of a barrier system, and typically consist of one-way ramps (i.e. earthen, mesh cone) (Langton and Clevenger 2021).

**Shelter**

To prevent stranding along barrier systems, shelters can be employed to provide protection from heat and cold, a place to rest (Langton and Clevenger 2021), and protection from predators. Shelter can consist of permanent or temporary structures such as modified PVC pipe (Langton and Clevenger 2021) or coverboards. These shelters provide the added benefit of offering a search area to determine barrier/shelter use and occupancy during performance assessments.

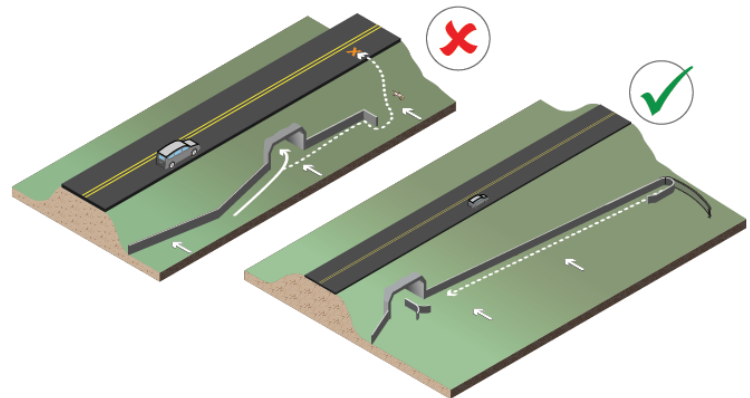

Example of a Turn-Around (from Langton and Clevenger 2021)

**Traffic Control and Calming**

The U.S. Department of Transportation's Manual on Uniform Traffic Control Devices (MUTCD) (2009 Edition) provides the national standard for traffic control devices used to regulate, warn, or guide traffic associated with public streets, highways, pedestrian facilities, bikeways, and private roads (USDOT 2009). Many traffic control devices have also been identified as infrastructure improvements that can enhance wildlife crossings (Meese et al. 2007).

Signage specifically designed to reduce wildlife-vehicle collisions by notifying drivers of wildlife crossings and reduced speed limits has been found to be ineffective or diminishes in effectiveness over time. However, certain signage could be effective in specific situations where other alternatives are impractical (Carr et al.

2003, Meese et al. 2007).

A preliminary review of traffic along Alma Bridge Road suggests that certain traffic control options may assist in moderating vehicle traffic year-round and during peak wildlife movement periods. Several of these traffic control options are summarized below. Additional options may be identified at a later date after site reconnaissance and further analysis as part of the identification and recommendation of future corrective actions and feasibility analyses in Phases II and III.

### **Destination and Distance Signs, Street Name Signs, and Advance Street Name Signs**

Destination and distance signs (Section 2D.36), street name signs (Section 2D.43), and advance street name signs (Section 2D.44) supply drivers on conventional roads (streets and highways) information concerning destinations that can be reached by way of alternate routes, and may include cardinal directions or distance to the placed named. Street name and advance street name signs provide drivers with advance information to prepare for crossing traffic and facilitate timely deceleration and/or lane changing in preparation for a turn (USDOT 2009).

At Alma Bridge Road, a review of destination and distance signs, street name signs, and advance street name sign placement at or in advance of key intersections on Highway 17, Alma Bridge Road, and other conventional roads could identify opportunities for additional or enhanced signage to direct traffic in such a way that drivers take the shortest route to and from their destination, avoid excess travel, and avoid missed turns, thereby minimizing their travel time along areas identified as road mortality hotspots.

### **Islands and Medians**

A raised island (Section 3I.01) or median (Section 3I.06) can discourage drivers from approaching certain areas. These may be designated by curbs, pavement edges, pavement markings, channelizing devices, or other devices, and can be marked with rumble sections, raised bars, or buttons projecting 1 to 3 inches above the pavement surface (USDOT 2009). Channelizing islands in particular can separate through-travel lanes in an intersection to control and direct traffic movement, divide opposing or same-direction traffic streams, and provide refuge for pedestrians, effectively regulating traffic and indicating the proper use of the intersection (AASHTO 2018).

During the spring 2022 pre-bid site-walk, doughnuts (i.e. skid-marks) were observed at the Alma Bridge Road and Soda Springs Road intersection, which suggests that drivers visit Alma Bridge Road for the express purpose of participating in illegal<sup>1</sup> street racing or sideshows. The Newt Patrol has observed these activities on Alma Bridge Road during the weekends, especially along the southern section of the road.

At Alma Bridge Road, a raised channelizing island may be useful at discrete locations to discourage drivers who visit the Project area to street race or participate in sideshows. Because channelizing islands may function similarly to a barrier wall to migratory newts; jump-outs or other considerations for newt movement would be a necessary component of the island design. Alma Bridge Road's open intersections, curved roads, and remote setting may encourage street racing and sideshows, which could attract additional traffic to the area and contribute to road mortality.

### **Transverse Rumble Strip Markings and Perceptual Treatments**

Transverse rumble strips (Section 3J.01) consist of intermittent narrow, transverse areas of rough-textured or slightly raised or depressed road surface that extend across the travel lanes to alert drivers to unusual vehicular traffic conditions. Through noise and vibration, transverse rumble strips attract the attention of drivers to features such as unexpected changes in alignment and conditions requiring a reduction in speed or a stop (USDOT 2009). Perceptual treatments consist of driving speed countermeasures such as peripheral transverse bars (peripheral pavement markings on both sides directly opposite to one another and

---

<sup>1</sup> On October 7, 2021, Governor Gavin Newsom signed into law California Assembly Bill 3 (effective July 1, 2025) that would amend Sections 13352 and 23109 of the California Vehicle Code to further discourage the prohibited exhibition of speed, including street racing and sideshows (informal demonstrations of vehicle stunts), on a highway.

perpendicular to the travel line) and optical speed bars (transverse pavement markings applied perpendicular to the direction of traffic flow in the middle of the travel lane). Under both treatments, line placement consisting of markings placed at increasingly closer spacing creates the optical effect of acceleration, with the goal of prompting drivers to reduce their speed (Calvi 2018). Another recent innovation in perceptual treatments includes painting the road to create an optical or illusory speed bump/hump on an otherwise level, painted surface, to encourage speed reduction.

At Alma Bridge Road, transverse rumble strip markings may be useful in drawing drivers' attention to speed reduction signs at locations identified as road mortality hotspots. Likewise, perceptual treatments may encourage drivers to reduce their speed. They may also encourage drivers to use alternate routes.

### **Speed Bumps and Speed Humps**

Speed bumps can be effective in reducing vehicle speed on local streets and areas where speed limits are relatively low (Meese et al. 2007).

At Alma Bridge Road, speed bumps and humps may be useful to discourage drivers who visit the Project area to street race or participate in sideshows. Alma Bridge Road's open intersections, curved roads, and remote setting may encourage such activities, which could attract additional traffic to the area and contribute to road mortality. Newt mortality may also be mitigated by lower vehicle speeds, though this effect may be minimal as newts are still incapable of actively avoiding slower traffic. They may also encourage drivers to use alternate routes.

### **Lighting**

Lighting placed in tandem with fencing and signage has been shown to be effective in reducing collisions with large mammals, especially at night, by increasing visibility and driver reaction time, and by reducing animal crossings for species who avoid lighted areas (Meese et al. 2007). These methods may not be as beneficial for nocturnally migrating herpetofauna, like the California newt.

At Alma Bridge Road, further analysis of California newt and other herpetofauna's behavioral response to lighted vs non-lighted areas may inform the utility of lighting as a deterrent to residency along the road deck. If these species are found to be averse to artificial lighting, low-profile, directional lightning may be useful in creating light "deserts" that both discourage species residency and improve visibility for drivers at locations identified as road mortality hotspots. Any actions taken to manipulate on-site lighting must consider the implications for newt navigation and the consequences for a variety of species that may cross Alma Bridge Road.

Artificial lighting is generally not recommended for nocturnally migrating species. However, newts may reject dark micropassages (such as a Type V crossing) that do not provide natural ambient lighting because they mimic a burrow entrance (Langton and Clevenger 2021). Diurnal amphibians may also reject passages with no light or less light. As such, artificial light that simulates natural light is recommended when ambient conditions do not illuminate the pathway of a crossing (FHWA 2011, Brehme and Fisher 2021). Micropassages with slotted ceilings may allow ample ambient light for species like the California newt that are deterred by artificial light but prefer some degree of visibility.

### **Area and Road Closures**

Area and road closures involve temporary to permanent temporal (time-based) "de-activations" that limit human access and use during specific times of day or periods of time for the purpose of improving habitat quality for wildlife by preserving movement corridors and reducing vehicle-wildlife mortality (Whittington et al. 2019, Huijser et al. 2021). Road closures have been employed to successfully prevent mass California newt road mortality at the East Bay Regional Park District's Tilden Regional Park in Berkeley, California. At Tilden Park, an informal road closure within park boundaries along South Park Drive commenced ca. 1988 during "the



rainy season” until a formal road closure “policy” was enacted in 1993. The closure takes place during the rainy season, defined as beginning with the first rainfall as early as November 1 and continuing until April 1 (Claggett 1989, EBRPD personal communication).

At Alma Bridge Road, area closures could include a seasonal change in hours of operation at trailheads and county parks to curtail early morning and evening park attendance (and consequently, vehicle traffic) during peak migration periods at locations identified as road mortality hot spots. Road closures, however, could result in significant disruptions to emergency ingress and egress, local residents and businesses, early morning recreational uses (such as fishing, rowing club, and boating) as well as visitors to the area, requires significant enforcement. As described above in the Roadways section, due to the current traffic/usage level of the road described herein, and notably Alma Bridge Road’s designation as an emergency access route, road closures and/or permit only use of the road is not considered feasible.

### **Educational/Interpretive Signage and Brochures**

In addition to the road sign alternatives identified above, educational and interpretive signage and brochures could be instrumental in helping to educate the public about the local population of newts and other herpetofauna, wildlife migration and dispersal, and the importance of wildlife crossings to provide safe passage for newts and other species across Alma Bridge Road.

At Alma Bridge Road, educational and interpretive signs could be placed at parking areas and trailheads, as well as private property locations with owner approval such as at strategic locations at the Los Gatos Rowing Club and Lupin Lodge. Educational brochures could be placed at designated trailhead kiosks, and could also be distributed to local residents through mass mailings.

### **Additional Design Criteria**

In addition to the above design criteria, wildlife passage design must also take into consideration other key users such as landowners, stakeholders, and visitors (recreationists), and incorporate any effects to these users into future feasibility analyses. Crossing structure design must also emphasize structures that do not impede key users; that do not unnecessarily interfere with existing, planned/designed traffic routes or drainage patterns; that prioritize durability to minimize repair/replacement; that do not require additional, costly maintenance needs; and that are compatible with regular maintenance practices such as routine paving, sealing, and striping.

# Corrective Action Opportunities

Based on this Technical Review to identify the background conditions surrounding Alma Bridge Road and the Project, the following “corrective actions” may simultaneously decrease wildlife mortality and increase wildlife movement permeability. Additional novel built or non-built corrective actions identified by the Phase I, Task 2 site investigation will be addressed during future phases of the Project. Corrective action recommendations may include a single corrective action type or a suite of corrective actions, and may be grouped in sets of proposed alternative recommendations.

**Table 3.** Preliminary Corrective Action Opportunities Identified

Corrective Action Type	Corrective Action	Goal
<b>Wildlife Passage System</b>		
Crossing Structures	Type 1A (mountain/hill tunnel)	Direct wildlife movement over roadway
	Type 1B (open span bridge)	Direct wildlife movement under roadway
	Type 2 (small [60-120 ft] open span bridge)	Direct wildlife movement under roadway
	Type 3 (small road underpass)	Direct wildlife movement under roadway
	Type 4 (small culvert)	Direct wildlife movement under roadway
	Type 5 (small culvert/passage)	Direct wildlife movement under roadway
	Type 6 (microbridge/raised roadway)	Raise traffic above movement corridor
Barriers	Guide Walls (permanent)	Redirect wildlife movement
	Fencing (temporary)	Redirect wildlife movement
<b>Traffic Control and Calming</b>		
Signage	Destination and Distance Signs	Shorten route(s), minimize travel time and distance
	Street Name Signs	Shorten route(s), minimize travel time and distance
	Advance Street Name Signs	Shorten route(s), minimize travel time and distance
Islands and Medians	Raised Island	Discourage additional traffic to the area
	Channelizing Island	Discourage additional traffic to the area
Transverse Rumble Strip Markings and Perceptual Treatments	Rumble Strips	Heighten driver awareness to speed reduction
	Perceptual Treatments	Heighten driver awareness to speed reduction
Speed Bumps/Speed Humps	Speed Bumps/Humps	Discourage additional traffic to the area
Lighting	Directional Lighting	Discourage species residency
	Lighting Existing Signs	Heighten driver awareness of newt crossing
Temporary Area and Road Closures and/or Permit Only Road Usage <i>(considered but not feasible)</i>	Temporary (or Seasonal) Area Closures or Permit Only Use	Lessen traffic during peak migration periods
	Temporary (or Seasonal) Road Closures or permit only use	Eliminate traffic during peak migration months

Corrective Action Type	Corrective Action	Goal
<b>Habitat Creation</b>		
Accessible Breeding Habitat	Establish New Breeding Sites	Direct wildlife to breed in created ponds east of the roadway to provide alternative breeding locations for the local newt population

## Stakeholder Involvement

The Project seeks to establish a formal collaboration process between interested multidisciplinary parties to support development of a suite of conceptual designs that represents the goals of the diverse Project stakeholders, the Project Partners, and the contractors. The Project team will convene a formal stakeholder working group that will inform the Project at key milestones.

# References

- American Association of State Highway and Transportation Officials (AASHTO). 2018. A Policy on Geometric Design of Highways and Streets (7th Edition). Washington, DC. 1,048 pp.
- Auza, Bea. 1969. Some Aspects of the Life History of the California Newt *Taricha torosa*. Master's Thesis. California State College, Hayward, CA. 98 pp.
- Brame, Arden H. 1968. The Number of Egg Masses and Eggs Laid by the California Newt, *Taricha torosa*. Journal of Herpetology 2(3/4): 169-170.
- Brehme, Cheryl S. and Robert N. Fisher. 2021. Research to Inform Caltrans Best Management Practices for Reptile and Amphibian Road Crossings. USGS Cooperator Report to California Department of Transportation, Division of Research, Innovation and System Information. 65A0553.
- Brehme, Cheryl S., Jeff A. Tracey, Brittany A.I. Ewing, Michael T. Hobbs, Alan E. Launer, Tritia A. Matsuda, Esther M. Cole Adelsheim, and Robert N. Fisher. 2021. Responses of migratory amphibians to barrier fencing inform the spacing of road underpasses: a case study with California tiger salamanders (*Ambystoma californiense*) in Stanford, CA, USA. Global Ecology and Conservation 31.
- Brehme, Cheryl S., Stephanie Barnes, Brittany Ewing, Cassie Vaughan, Michael Hobbs, Charles Tornaci, Philip Gould, Sarah Holm, Hanna Sheldon, and Robert N. Fisher. 2022. Research to Inform Passage Spacing for Migratory Amphibians and to Evaluate Efficacy and Designs for Open Elevated Road Passages. USGS Cooperator Report to Nevada Department of Transportation, Transportation Pooled Fund Program Project P342-20-803.
- Bury, R. Bruce, Hartwell H. Welsh, Jr., David J. Germano, and Donald T. Ashton. 2012. Western Pond Turtle: Biology, Sampling Techniques, Inventory and Monitoring, Conservation, and Management. Northwest Fuana 7: 128 pp.
- California Department of Fish and Wildlife (CDFW). 2022. California Natural Diversity Database (CNDDDB). RareFind Version 5.2.14. Database Query for the Los Gatos USGS 7-½ minute Quad. Wildlife and Habitat Data Analysis Branch. August 3, 2022 website query.
- Calvi, Alessandro. 2018. Investigating the Effectiveness of Perceptual Treatments on a Crest Vertical Curve: A Driving Simulator Survey. Transportation Research Part F: Traffic Psychology and Behavior 58: 1074-1086.
- Carr, Theresa, Radcliffe Dacanay, Kevin Drake, Charl Everson, Arianne Sperry, and Kerri Sullivan. 2003. Wildlife Crossings: Rethinking Road Design to Improve Safety and Reconnect Habitat. Master of Urban and Regional Planning Workshop Projects. 142. <http://archives.pdx.edu/ds/psu/18464>
- Claggett, Peter. 1989. Migration Patterns of *Taricha torosa* in Tilden Regional Park. Technical Report for the East Bay Regional Park District.
- County of Santa Clara. 1994. Santa Clara County General Plan 1995-2010: Book B. Land Use Policies. Rural Unincorporated Area Issues and Policies. Adopted December 20, 1994. URL: [https://stgenpln.blob.core.windows.net/document/GP\\_Book\\_B.pdf](https://stgenpln.blob.core.windows.net/document/GP_Book_B.pdf).
- County of Santa Clara Planning Office. 2016. Land Use Plan, October 2016. Use and Area Designations. 1995 Santa Clara County General Plan. URL: [https://stgenpln.blob.core.windows.net/document/landuse\\_plan\\_map.pdf](https://stgenpln.blob.core.windows.net/document/landuse_plan_map.pdf).

- Cowardin Lewis M, Virginia Carter, Francis C. Golet, and Edward T. LaRoe. 1979. Classification of wetlands and deepwater habitats in the United States. U.S. Dept. Interior, Fish and Wildlife Service, FWS/OBS-79/31.
- Endler, John. 1970. Kinesthetic Orientation in the California Newt (*Taricha torosa*). Behavior 37(1): 15-23.
- Federal Highway Administration (FHWA). 2011. Wildlife Crossing Structure Handbook, Design and Evaluation in North America. U.S. Department of Transportation.  
<https://nrm.dfg.ca.gov/FileHandler.ashx?DocumentID=134712>
- H.T. Harvey & Associates. 2021. Alma Bridge Road-Related Newt Mortality Study (Project #4301-02). Technical report prepared for Midpeninsula Open Space District and Peninsula Open Space Trust. 12 November. 57 pp.
- Hedrick, Brandon P., Abby Vander Linden, Edward Watt, Patrick M. O’Roark, Samantha A. Cordero, and Christopher Sutherland. 2019. Keeping salamanders off the street: An assessment of one of the first amphibian road tunnels in the United States 30 years after installation. Journal of Urban Ecology. doi: 10.1093/jue/juz023.
- Helldin, Jan Olof and Silviu O. Petrovan. 2019. Effectiveness of small road tunnels and fences in reducing amphibian roadkill and barrier effects at retrofitted roads in Sweden. PeerJ. DOI 10.7717/peerj.7518
- Huijser M.P., R.J. Ament, M. Bell, A.P. Clevenger, E.R. Fairbank, K.E. Gunson KE, and T. McGuire. 2021. Animal Vehicle Collision Reduction and Habitat Connectivity Study (Literature Review). Prepared for Nevada Department of Transportation. December. 117 pp.
- Kuchta, Shawn. 2005. *Taricha torosa* (Rathke, 1833) California Newt (pp 904-908). In book: Amphibian Declines: The Conservation Status of United States Species. University of California Press, Berkeley, CA. 1,094 pp.
- Jacobson, Sandra L., Leslie L. Bliss-Ketchum, Catherine E. de Rivera, and Winston P. Smith. 2016. A Behavior-Based Framework for Assessing Barrier Effects to Wildlife from Vehicle Traffic Volume. Ecosphere 7(4):e01345. 10.1002/ecs2.1345
- Jarvis, Laurence E., Michael Hartup, and Silviu O. Petrovan. 2019. Road mitigation using tunnels and fences promotes site connectivity and population expansion for a protected amphibian. European Journal of Wildlife Research 65(27): 1-27.
- Langton, Thomas E. and Anthony P. Clevenger. 2012 Measures to Reduce Road impacts on Amphibians and Reptiles in California. Best Management Practices and Technical Guidance. Prepared by Western Transportation Institute for California Department of Transportation, Division of Research, Innovation and System Information. March. 127 pp.
- Matos, Catia, Silviu Petrovan, Alastair I. Ward, and Philip Wheeler. 2017. Facilitating permeability of landscapes impacted by roads for protected amphibians: patterns of movement for the great crested newt. PeerJ: 1-18.
- McLaughlin, R.J., J.C. Clark, E.E. Brabb, and E.J. Helley. 2001. Geologic Maps and Structure Sections of the Southwestern Santa Clara Valley and Southern Santa Cruz Mountains, Santa Clara and Santa Cruz Counties, California. United States Geological Survey Miscellaneous Field Studies Map MF-2373. Sheet 1: Los Gatos Quadrangle. URL: <https://pubs.usgs.gov/mf/2002/2373/lgmap.pdf>.
- Meese, Robert J., Fraser M. Shilling, and James F. Quinn. 2007. Wildlife Crossings Guidance Manual. California Department of Transportation. October. 87 pp.

- Midpeninsula Regional Open Space District (MROSD). 2017. Midpeninsula Regional Open Space District Sensitive Species List. January 2017.
- Miller, Malcom R. and Marilyn E. Robbins. 1954. The Reproductive Cycle in *Taricha torosa* (*Triturus torosus*). *Journal of Experimental Zoology* 125:3. 415-445pp.
- Natural Resources Conservation Service. 2019. Map Unit Description. Soil Survey of the Santa Clara Area, California, Western Part. United States Department of Agriculture. Survey area version 8. September 16, 2019. URL: [https://stgenpln.blob.core.windows.net/planning/SoilsDocs/MapUnitDescriptions\\_w.pdf](https://stgenpln.blob.core.windows.net/planning/SoilsDocs/MapUnitDescriptions_w.pdf).
- Newt Patrol. (2022). Pacific Newt Roadkill (Main Project)- Lexington Reservoir. iNaturalist open source software. Retrieved October 7, 2022, from <https://www.inaturalist.org/projects/pacific-newt-roadkill-main-project-lexington-reservoir>
- Ottburg, Fabrice G. W. A. and Edgar A. van der Grift. 2019. Effectiveness of Road Mitigation for Common Toads (*Bufo bufo*) in the Netherlands. *Frontiers in Ecology and Evolution* 7(23): 1-11. doi: 10.3389/fevo.2019.00023.
- Parsons, Anne. 2021. Mass Mortality of Pacific Newts at Lexington Reservoir: Bearing Witness to the Decimation of Two Populations - Summary of Four Migration Seasons (Nov. 2017 – May 2021). Technical Report. 5 June. 52 pp.
- Parsons, Anne. 2022. Pacific Newt Roadkill (Main Project) - Lexington Reservoir (iNaturalist Project Page). URL: <https://www.inaturalist.org/projects/pacific-newt-roadkill-main-project-lexington-reservoir>. Accessed August 11, 2022.
- Pimental, Richard. Inter- and Intra-habitat Movements of the Rough-Skinned Newt, *Taricha torosa granulosa* (Skilton). *The American Midland Naturalist* 63(2): 470-496.
- Ritter, William E. 1897. The Life-History and Habits of the Pacific Coast Newt (*Diemyctylus torosus* Esch.). *Proceedings of the California Academy of Sciences* 3(1), p. 73.
- Santa Clara County Planning and Development 2022a. Geologic Hazard Zones. Interactive mapping tool. URL: <https://sccplanning.maps.arcgis.com/apps/webappviewer/index.html?id=5ef8100336234fbdafc5769494cfe373>. Accessed August 11, 2022.
- Santa Clara County Planning and Development 2022b. Soils of Santa Clara County. Interactive mapping tool. URL: <https://sccplanning.maps.arcgis.com/apps/webappviewer/index.html?id=39cca200bb4743eeeab0e15838ab85d2>. Accessed August 11, 2022.
- Santa Clara County Roads and Airports 2022. Volume Summary Report: Alma Bridge Road. Data from 08:00 - 01/25/2022 to 10:44 - 02/02/2022. March 23, 2022.
- Santa Clara Valley Water District (Valley Water). 2021. Local Dams and Reservoirs: Lexington Reservoir and Lenihan Dam. Accessed online at: <https://www.valleywater.org/your-water/local-dams-and-reservoirs>.
- Santos, Sara M., Felipe Carvalho, and António Mira. 2011. How long do the dead survive on the road? Carcass persistence probability and implications for road-kill monitoring surveys. *PLoS One* 6 (9), e25383.
- Stebbins, Robert C. 2003. *Western Reptiles and Amphibians* (3<sup>rd</sup> Ed.). Peterson Field Guides. Houghton Mifflin Company, New York, New York. 533 pp.

- Stebbins, Robert C. and Samuel M. McGinnis. 2012. Field Guide to Amphibians and Reptiles of California (Revised Ed.). University of California Press, Berkeley and Los Angeles, California. 96 pp.
- Storer, Tracy Irwin. 1925. A Synopsis of the Amphibia of California. University of California, Publications in Zoology 27: 1-342.
- Thompson, Robert C., Amber N. Wright, and H. Bradley Shaffer. 2016. California Amphibian and Reptile Species of Special Concern. California Department of Fish and Wildlife and University of California Press. Oakland, CA. 390 pp.
- Trenham, Peter C. 1998. Demography, migration, and metapopulation structure of pond breeding salamanders. Ph.D. Dissertation, University of California, Davis.
- Twitty, Victor Chandler. 1942. The species of Californian Triturus. Copeia 1942:65-76.
- Twitty, Victor Chandler. 1961. Experiments on homing behavior and speciation in *Taricha*, in Blair, W. F. (ed.) Vertebrate Speciation. University of Texas Press, Austin, TX.
- Twitty, Victor Chandler. 1964. *Taricha rivularis* (Twitty) red-bellied newt. Catalogue of American Amphibians and Reptiles 9:1-2.
- U.S. Department of Transportation (USDOT). 2009. Manual on Uniform Traffic Control Devised for Streets and Highways (including Revision 1 and Revision 2). 2009 Edition. U.S. Department of Transportation and the Federal Highway Administration. [mutcd2009r1r2edition.pdf \(dot.gov\)](#)
- U.S. Fish and Wildlife Service (USFWS). 2022a. Endangered Species Act Species List (USFWS Endangered Species Program): Species that Should be Considered in an Effects Analysis for Your Project. IPaC - Information, Planning, and Conservation System. August 3, 2022 website query.
- U.S. Fish and Wildlife Service (USFWS). 2022b. National Wetlands Inventory-Mapper. U.S. Department of the Interior, Fish and Wildlife Services. URL: <https://fwprimary.wim.usgs.gov/wetlands/apps/wetlands-mapper/>. Accessed 12 August 2022.
- U.S. Geological Survey (USGS). 2022a. The National Map-National Hydrography dataset. URL: <https://apps.nationalmap.gov/viewer/>. Accessed 12 August 2022.
- U.S. Geological Survey (USGS). 2022b. U.S. Quaternary Faults. Interactive mapping tool. USGS Geologic Hazards Science Center Golden, CO. URL: <https://usgs.maps.arcgis.com/apps/webappviewer/index.html?id=5a6038b3a1684561a9b0aadf88412fcf>. Accessed August 11, 2022.
- Van der Griff, Edgar A., Fabrice Ottburg, and Robert P. H. Snep. 2010. Monitoring wildlife overpass use by amphibians: do artificially maintained humid conditions enhance crossing rates? Pages 341-347 in Proceedings of the 2009 international conference on ecology and transportation. P. J. Wagner, D. Nelson, and E. Murray, editors. Center for Transportation and the Environment, North Carolina State University, Raleigh, North Carolina, USA.
- Whittington, Jesse, Petah Low, and Bill Hunt. 2019. Temporal Road Closures Improve Habitat Quality for Wildlife. Scientific Reports 9(3772).
- Zeiner, D.C., W.F. Laudenslayer, Jr., K.E. Mayer, and M. White, eds. 1988-1990. California Wildlife Habitat Relationship System. Vol. I-III. California Depart. of Fish and Game, Sacramento, California.